

Magnetic cylinder sensor

MZT6 series

DC 3-wire, T-Slot cylinder

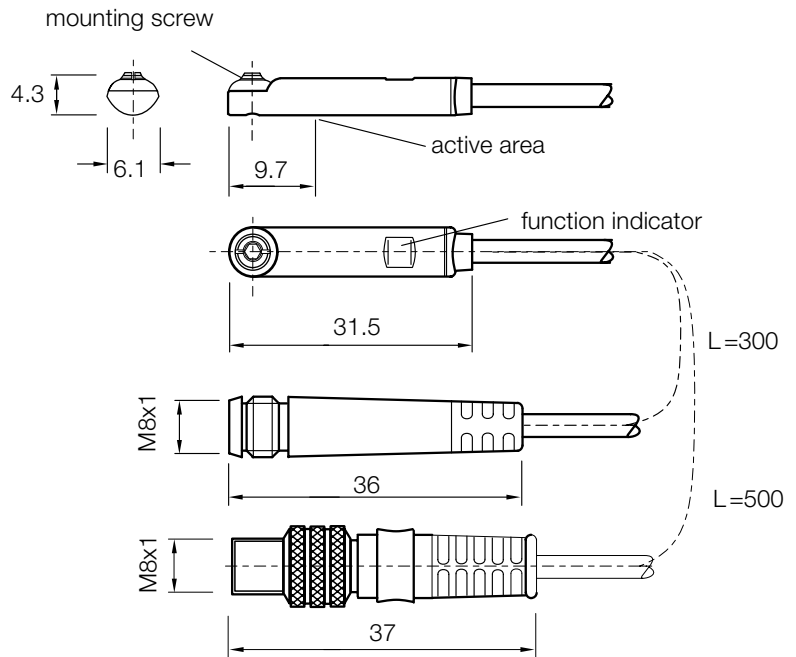

Features



- Non-contact detection of piston position in pneumatic cylinders
- **Mountable from the top**
- For all common used T-slot cylinder e.g. Festo, SMC
- Plastic housing with nickel silver bushing and hexagon socket/slot screw
- Connection cable or connector on cable
- Enclosure rating IP 67
- LED function indicator
- Magneto-resistive element

Accessories

Round connector

Connection diagram

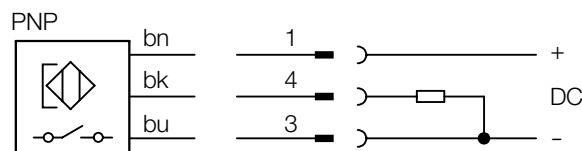



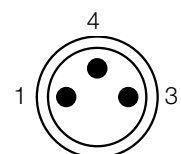



Wire colour	Contact	Assignment
bn brown	1	+ V DC
bk black	4	NO
bu blue	3	- V DC



Electrical and mechanical data

Operating voltage U_b	10 ... 30 V DC	Wire-break protection	yes
Ripple U_{ss}	$\leq 10\%$ of U_b	Short-circuit protection	yes
Voltage drop U_d	$\leq 2,5$ V	(pulsed)	
Power consumption (without load)	≤ 10 mA	Reverse polarity protection	yes
Continuous current I_a	≤ 100 mA	Power-up pulse suppression	yes
Hysteresis H	$\leq \text{min. } 0,5$ mT	Enclosure rating to EN 60529	IP 67
Repeatability R	$\leq 0,1$ mT	Shock and vibration stress	30 g, 11 ms 10 to 55 Hz, 1 mm
(U_b and T_a constant)		Ambient temperature T_a	- 25 ... + 75 °C
EMC	to EN 60 947-5-2	Housing material	Plastic
		Connection cable 2 m	PVC, 3 x 0,14 mm ²
		Connection cable with M8x1 mm	PUR

Selection table

Response sensitivity in mT	Sensing face	Switching-output	Output function	Switching frequency in Hz	Connection	Type	Order number
2,8		PNP		5000	Cable 2 m	MZT6-03VPS-KWO	1023970
2,8		PNP		5000	Cable w. M8 x 1 mm	MZT6-03VPS-KPO	1023971
2,8		PNP		5000	Leitung m. M8 x 1 mm with knurled screw	MZT6-03VPS-KRO	1023972



Great Britain

Erwin Sick Ltd.
Waldkirch House
39 Hedley Road, St. Albans
Hertfordshire AL 1 5BN
☎ +44 17 27-83 11 21
Fax +44 17 27-85 67 67
erwin@sick.co.uk

USA

SICK, Inc.
6900 West 110th Street
Bloomington, MN 55438
☎ +1 (952) 9 41-67 80
Fax +1 (952) 9 41-92 87
WATS 1-800-325-7425
info@sickoptic.com

Australia

Erwin Sick Optic-Electronic
Pty. Ltd. Head Office, P.O. Box 214
899 Heidelberg Road
Ivanhoe, Vic. 3079, Australia
☎ +61 39 49 74 10 0
(0 08) 33 48 02 - toll free
Fax +61 39 49 71 18 7
sick@werple.net.au