

1

Connectors

GA Series

Circular connectors
to industry standard

Catalogue A25.en

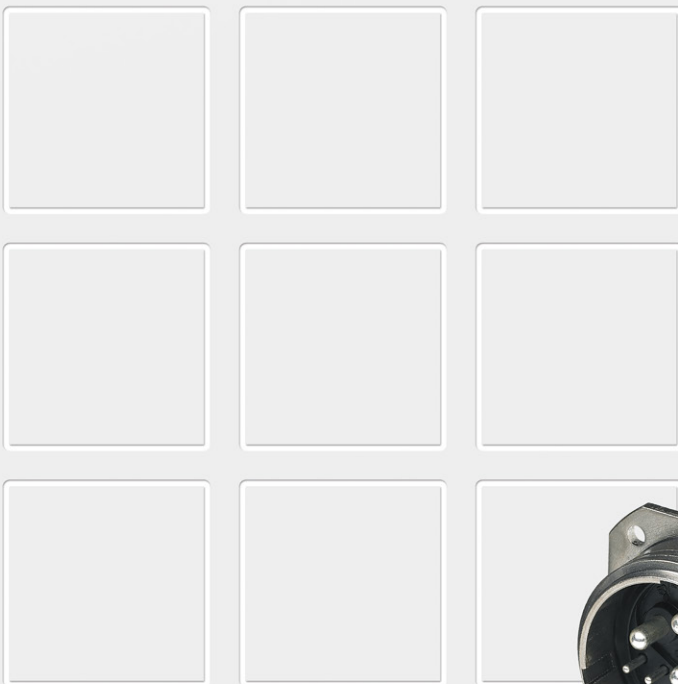

More information
schaltbau.com

Industrial connectors, GA series

Series GA industrial connectors are high-quality special purpose connectors.

The 15 pole circular connector has a housing made of high strength aluminium magnesium alloy. The contact arrangement is a combination of 4 power contacts and 11 control contacts.

The thermoset contact inserts allow the connector to be used for a wide temperature range. Cable-connecting and flange mount plugs and receptacles with different threads for cable glands are available as stock items. Protection caps are available as accessory. Special variants upon request!

Sealed to IP67/IP69K: The pin contacts and solder cups are moulded watertight in the contact inserts of the receptacles, so that there is no ingress of water even when the connector is unplugged.

The polarized key and keyway construction of the connector prevents the contacts from touching the insulator, thus making possible a "blind" mating of the connector halves. The functional threaded coupling ensures reliable connection.

Features

- High-quality robust metal housing
- 4 power and 11 control contacts
- Functional threaded coupling with polarized key and keyway construction for easy and reliable connection
- Receptacles watertight to IP67/IP69K when mated and unmated
- Resistant to corrosive liquids
- Electrical and mechanical characteristics to IEC 61984

Applications

- Machine tool building
- Test bays
- Custom machine building
- Renewable energy resources

GA series

Overview

GA series

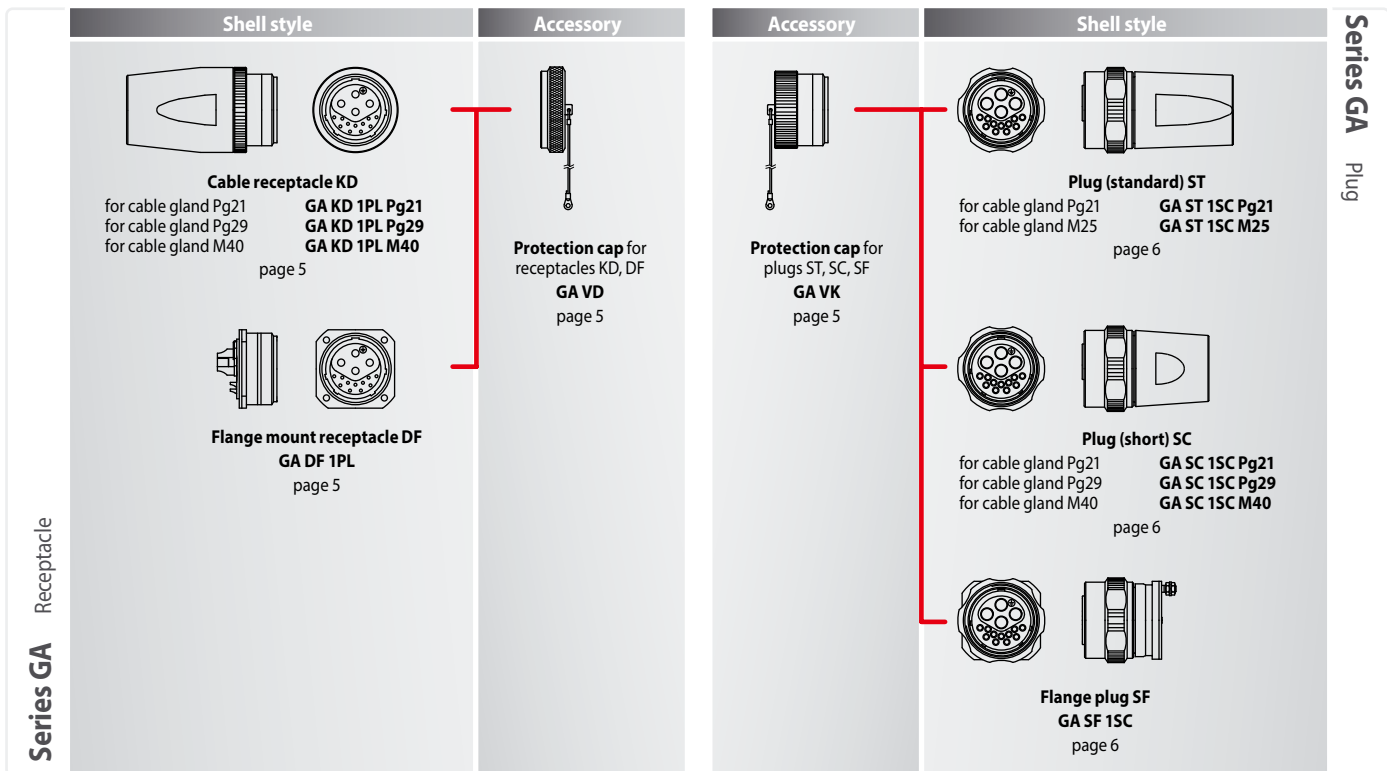

Competence

For decades Schaltbau has been a well-known and competent manufacturer of products designed for use in harsh environments. Typical applications:

- Industry
- Military communications
- Traffic engineering

Based on the success of the proven industrial connectors, the high quality and reliability typical of Schaltbau is being continued by the GA Series.











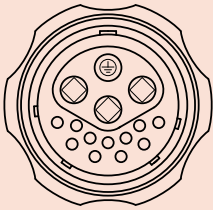
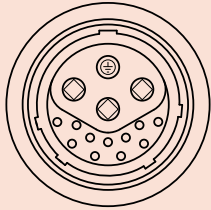





















Standards

GA series

- Electrical and mechanical characteristics of connectors in accordance with IEC 61984
- Degree of protection according to IEC 60529 (IP code)
- UL 94-V0 flammability rating of plastics used

Specifications

GA series

Series GA	Plugs	Receptacles
Max. number of contacts	3-polig + PE + 11	3-polig + PE + 11
Contact arrangement		
Contact identification marked on		
Insert:	1	1
Pin insert:	2 3 4	4 3 2
Socket insert:	15 14 13 12 10 8 6 5 11 9 7	5 6 7 8 10 12 14 15 9 11 13
	Rear view	Front view
Rated voltage (IEC 60038) at pollution degree 3 (IEC 60512)	 400 V / 400 V  Earth contact  25 V / 60 V	 400 V / 400 V  Earth contact  25 V / 60 V
Orientation / keys and keyways	1 / 5	1 / 5
Current rating of individual contact, max. see page 7	 3 x 50 A  11 x 16 A	 3 x 50 A  11 x 16 A
Contact size / type	 Ø 4 mm / Crimp contact, Type C  Ø 1.58 mm / Crimp contact, Type A	 Ø 4 mm / Solder contact  Ø 1.58 mm / Solder contact
PE contact Contact size / type	 Ø 4 mm / Crimp contact, Type C	 Ø 4 mm / Solder contact
Max. rated current of individual contact		
Wire gauge		
0.50 mm ²	---	---
0.75 mm ² ... 1.00 mm ²	 10 A / Crimp contact, Type A	---
1.50 mm ²	 16 A / Crimp contact, Type C *1	 10 A / Solder contact
2.50 mm ²	---	---
4.00 mm ²	 35 A / Crimp contact, Type C *2	---
6.00 mm ²	 50 A / Crimp contact, Type C	 50 A / Solder contact
PE contact		
Wire gauge		
1.50 mm ²	 Crimp contact, Type C *1	---
4.00 mm ²	 Crimp contact, Type C *2	---
6.00 mm ²	 Crimp contact, Type C	 Solder contact
Contact resistance (IEC 60512-2)	 .  < 2 mΩ /  < 10 mΩ	
Insulation resistance (IEC 60512-2)	 .  > 5,000 MΩ /  > 5,000 MΩ	
Temperature range *3	-25° C ... +60° C	
Degree of protection (IEC 60529)	mated: IP67 / IP69K	mated/not mated: IP67 / IP69K
Test standard (IEC 60068-1) (t _{min} [°C]/t _{max} [°C]/t _{testing time} [days])	-25/60/21	
Mechanical endurance (mating cycles) (IEC 60512-5, test 9a)	2,000	
Retention force (crimp contacts)	> 75 Nm	--- *4
Materials		
Shells	Aluminium or PA 66 (only GA SC 1SC xxx)	Aluminium
Inserts	Thermoset	Synthetic rubber
Seals	Silicone rubber (SIR)	Perbunane (NBR)
Flammability rating (contact insert)	UL94V-0	UL94V-0
Contacts		
Terminal type	Crimp	Solder
Material	Crimp-type copper wrought alloy	Solder-type copper wrought alloy
Plating	Ag	Ag



*1 With reducing bushing RH-6,0/1,5 - included with contacts

*2 With reducing bushing RH-6,0/4,0 - included with contacts

*3 Operating temperatures exceeding 25°C account for a lower current rating, see derating diagram on page 7

*4 Solder contacts are moulded in the contact insert of the receptacle shell
Subject to change

Ordering code

GA series

Our GA Series connectors have a modular structure. All components of the connector are shown in the Overview on page 2.

You will find the ordering code for a connector variant as presented in this catalogue in the table opposite its dimension diagram.

• Ordering code for »plug and receptacle shells«

Example: **GA KD 1PL Pg21**

Series	GA	Designation of series
Shell style (with contact insert 3+PE+11)	KD	Cable receptacle
Contact arrangement	1	3 + PE + 11
Contact type	P	Pin contact (receptacle)
Terminal type	L	Solder, pin contacts (receptacle)
Threaded connection for cable gland	Pg21	Thread Pg21

• Ordering code for »Protection caps«

Example: **GA VD**

Series	GA	Designation
Type of cap	VD	Protection cap for receptacle styles KD, DF
	VK	Protection cap for plug styles ST, SC, SF

• Ordering code for »tools«

Example: **AWZ-A**

Extraction tool	AWZ	Designation
for contacts	A	Crimp contact, Type A (BAC-1,00-Ag)
	C/H	Crimp contact, Type C (BAC-6,00-Ag)

Example: **CWZ-600-1**

Crimp tool	CWZ-600-1	Crimp tool for wire range 0.14 ... 6 mm ²
-------------------	-----------	--



Note:

This catalogue shows only stock items.

For some variants minimum quantities apply.

Please ask for the conditions.

Special variant:

If you need a special variant of the connector, please do not hesitate to contact us. Maybe the type of connector you are looking for is among our many special designs. If not, we can also supply customized designs. In this case minimum quantities apply.

GA KD 1PL xx Cable receptacle

GA series

Dimensions

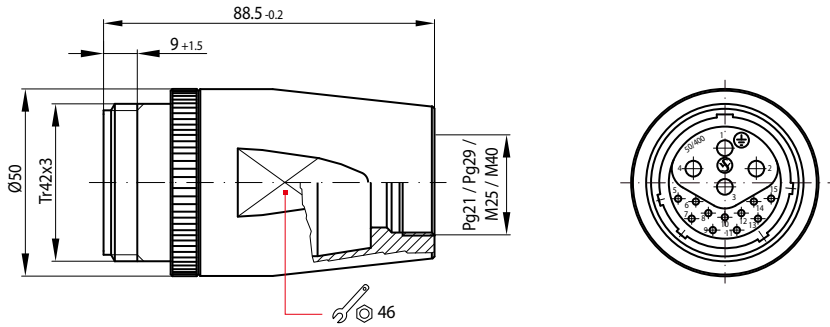

Note:

- The solder-type pin contacts are moulded in the insert of the receptacle shell.
- Cable glands are not included in the delivery.

Ordering code

Example:

GA KD 1PL Pg21

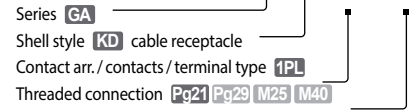

Ordering code	Threaded connection for
GA KD 1PL Pg21	Cable gland Pg21
GA KD 1PL Pg29	Cable gland Pg29
GA KD 1PL M40	Cable gland M40

Accessory

- Protection cap **GA VD**

GA DF 1PL Flange mount receptacle

GA series

Dimensions



Note:

- The solder-type pin contacts are moulded in the insert of the receptacle shell.
- Gasket included in the delivery.

Ordering code

Example:

GA DF 1PL

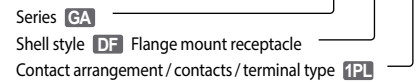

Ordering code
GA DF 1PL

Accessory

- Protection cap **GA VD**

GA VD / GA VK Protection cap for receptacle / plug

GA series

Dimension diagram GA VD

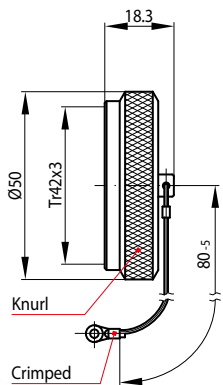

Dimension diagram GA VK

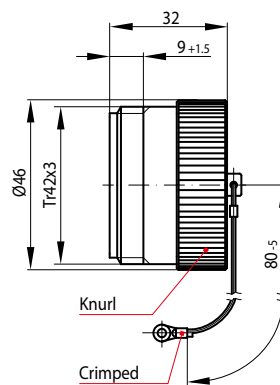

Ordering code

Example:

GA VD



Ordering code	Description
GA VD	Protection cap for receptacles KD, KF
GA VK	Protection cap for plugs ST, SC, SF



Note: Protection cap delivered with loose cord end and separate ferrule and eyelet. Optional delivery with loop or attached eyelet (e.g. crimping of ferrule or eyelet with flat pliers).

GA ST 1ST xx Plug, standard

GA series

Dimensions

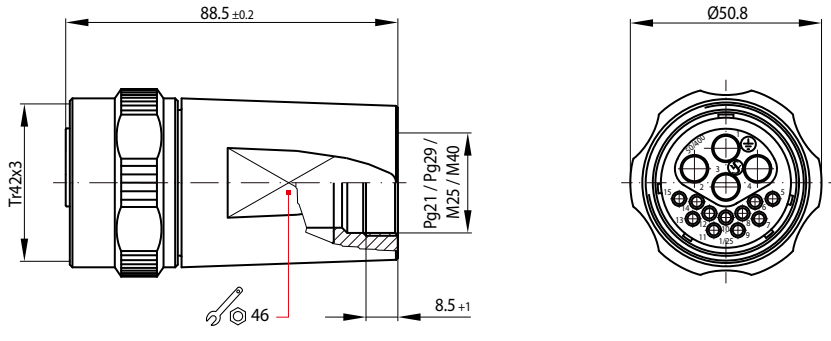

Note:

- The plug shell comes with the following crimp contacts added as loose parts:
- Socket contacts: 4x BCC-6,00-Ag, 11x BAC-1,00-Ag,
- Reducing bushings: 4x RH-6,0/4,0, 4x RH-6,0/1,5
- Cable glands are not included in the delivery.

Ordering code

Example:

GA ST 1SC Pg21

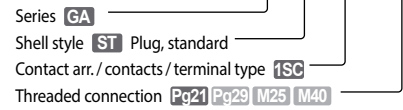

Ordering code	Threaded connection for
GA ST 1SC Pg21	Cable gland Pg21
GA ST 1SC Pg29	Cable gland Pg29
GA ST 1SC M25	Cable gland M25
GA ST 1SC M40	Cable gland M40

Accessory

- Protection cap **GA VK**

GA SC 1SC Plug, short

GA series

Dimensions

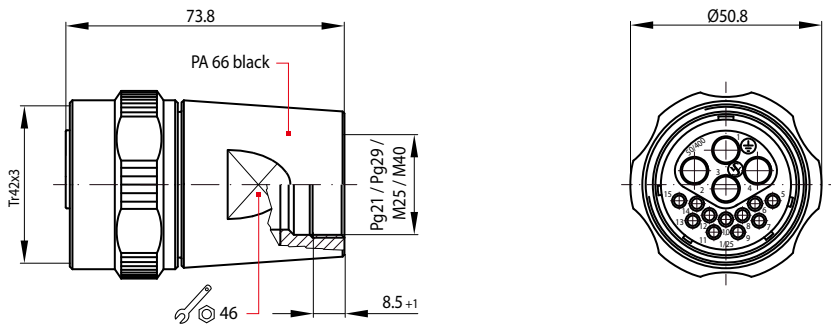

Note:

- The plug shell comes with the following crimp contacts added as loose parts:
- Socket contacts: 4x BCC-6,00-Ag, 11x BAC-1,00-Ag,
- Reducing bushings: 4x RH-6,0/4,0, 4x RH-6,0/1,5
- Cable glands are not included in the delivery.

Ordering code

Example:

GA SC 1SC Pg21

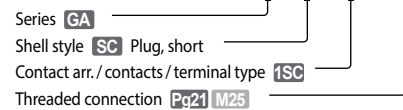

Ordering code	Threaded connection for
GA SC 1SC Pg21	Cable gland Pg21
GA SC 1SC M25	Cable gland M25

Accessory

- Protection cap **GA VK**

GA SF 1SF Flange plug

GA series

Dimensions

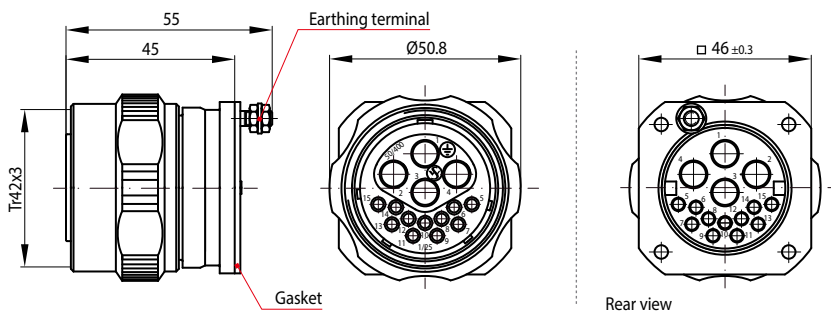

Note:

- The plug shell comes with the following crimp contacts added as loose parts:
- Socket contacts: 4x BCC-6,00-Ag, 11x BAC-1,00-Ag,
- Reducing bushings: 4x RH-6,0/4,0, 4x RH-6,0/1,5

Ordering code

Example:

GA SF 1SC

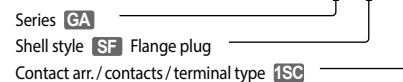

Ordering code
GA SF 1SC



Accessory

- Protection cap **GA VK**

Contacts Plugs: Crimp contacts, Receptacles: Solder contacts

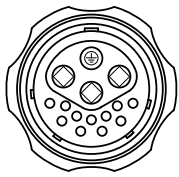
GA series

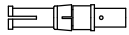
Plugs ST / SC / SF
Crimp type socket contacts

# of	Drawing	Contact type	Identification	Ordering code
3x 1x		Crimp, Type C	1 wide groove	BCC-6,00-Ag
11x		Crimp, Type A	1 groove	BAC-1,00-Ag

*1 With reducing bushing RH-6,0/4,0 - included with contacts

*2 With reducing bushing RH-6,0/1,5 - included with contacts

Specifications

Wire gauge	Rated current of individual contact
6.0 / 4.0*1 / 1.5*2 mm ²	50 / 35*1 / 16*2 A
0.75 ... 1 mm ²	10 A

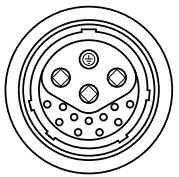
Receptacles KD / DF
Solder type pin contacts (not replaceable)

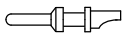
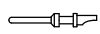
# of	Drawing	Contact type	Identification	Ordering code
3x 1x		Solder	---	---*3
11x		Solder	---	---*3

*3 Moulded in the contact insert of the receptacle shell; item cannot be ordered individually

Specifications

Wire gauge	Rated current of individual contact
6.0 mm ²	50 A
1.5 mm ²	16 A

Deratingkurve

GA series

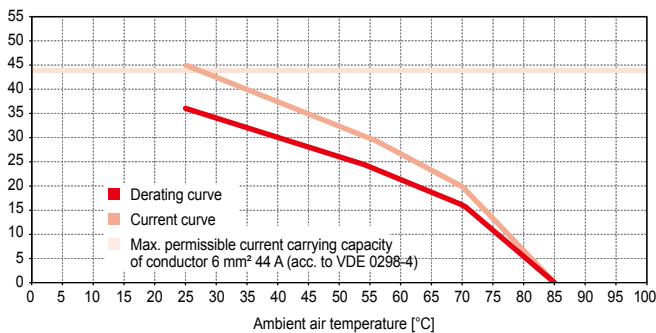
Derating curve power contacts (3x 1x)

Note:

- According to VDE 0298-4 the wire gauge of the conductor should be determined in this way that within the limits of its specified current carrying capacity there will be no heating of the conductor exceeding the permissible operating temperature at any place or any time.
- The derating diagram shows the permissible operating range.
- Control and test procedures according to IEC 60512-3, test Sb.

Tools Extraction tools AWZ-A and AWZ-C/H, Crimp tool CWZ-600-1

GA series

AWZ-x Extraction tool

Ordering code	Extraction tool for
AWZ-A	Extraction tool for contacts, Type A
AWZ-C/H	Extraction tool for contacts, Type C and H



Note: Extraction tool for crimp-type socket contacts as used for plugs BAC-1,00-Ag (Type A) and BAC-6,00-Ag (Type C)

CWZ-600-1 Crimp tool

Ordering code	Crimp tool for
CWZ-600-1	Contacts SAC-x*, BAC-x*, SBC-x, BBC-x, SCC-x, BCC-x * Do not use for contacts SAC-2.50-xx, BAC-2.50-xx
Tool frame M22520/1-01 and Turret M22520/1-02 (No fig.)	For contacts SAC-2.50-xx, BAC-2.50-xx only. Crimp tool and turret from DMC or Buchanan. Order direct from OEM.



Note: Crimp tool for crimping the socket contacts of the plug BAC-1,00-Ag and BAC-6,00-Ag



Assembly and installation dimensions

GA series

- Cable receptacle ↔ plug, standard,
Cable receptacle ↔ plug, short

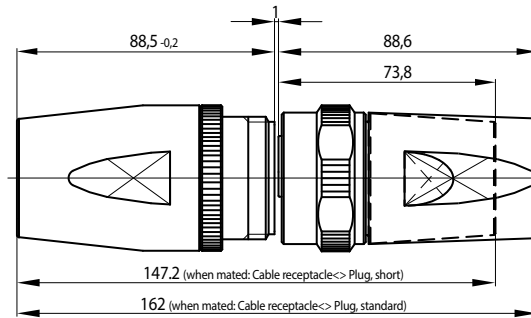

- Cable receptacle ↔ flange plug

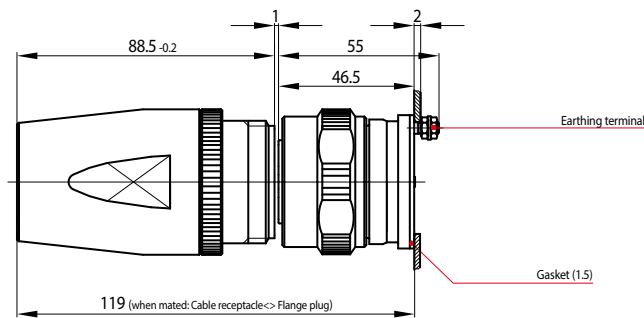

- Flange mount receptacle ↔ plug, standard,
Flange mount receptacle ↔ plug, short

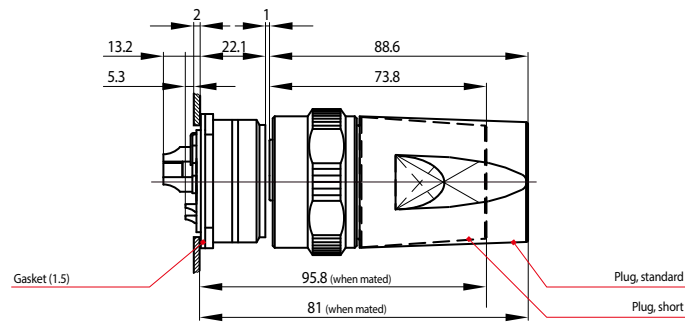

Mounting holes Flange mount receptacle GA DF 1PL, Flange plug GA SF 1SC

GA series

- for flange mount receptacle GA DF 1PL

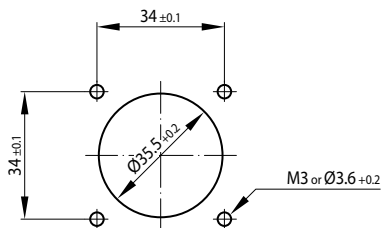

- for flange plug GA SF 1SC

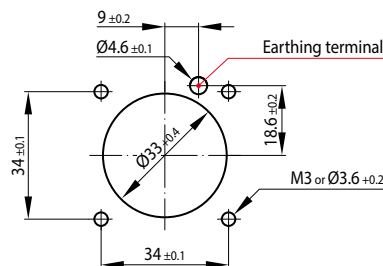

! Note: Flange mount receptacle (GA DF 1PL) and flange plug (GA SF 1SC) are to be front-mounted. With plug (GA SF 1SC) please mind the extra hole for earthing.

Assembly instructions

GA series

• Assembly of cable plug GA ST 1SC:

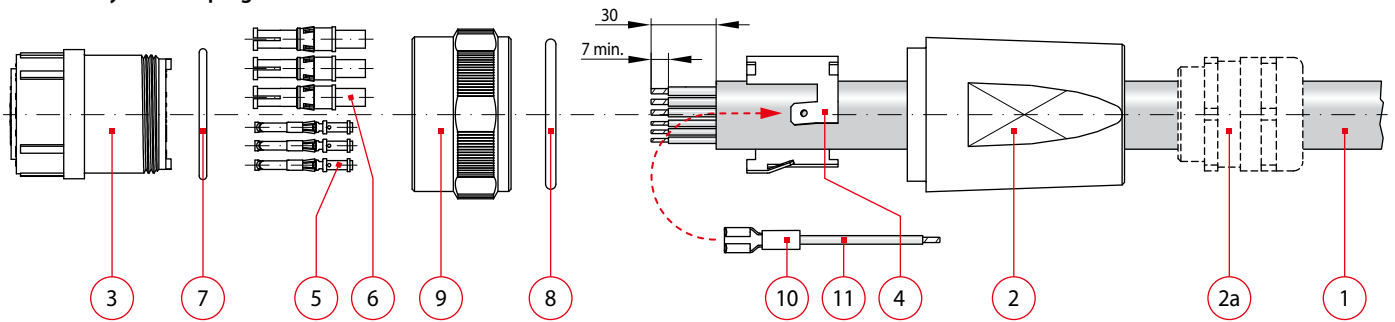

• Assembly of cable receptacle GA KD 1PL:

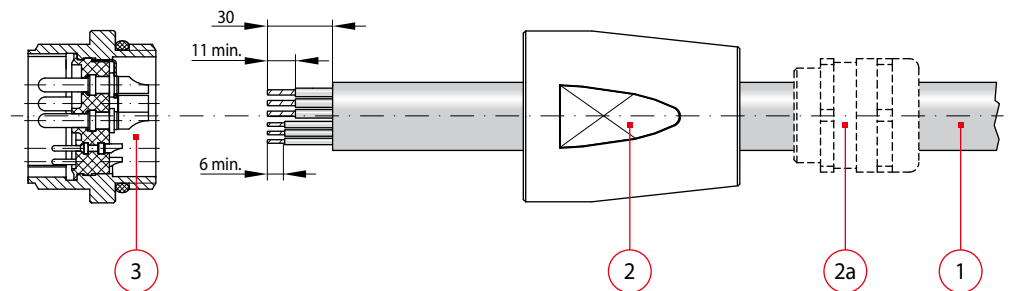

Assembly of cable plug

- Slide thread cable gland (OEM part) (2a) and backshell (2) on cable (1)
- Crimp Grounding cable (11) to cable lug (10) and plug it on the earthing sleeve then slide it over cable (1)
- Place O-ring (8) in coupling ring (9) and slide it on cable (1)
- Slide O-ring (7) on contact insert (3)
- Strip jacket of cable (1) to a length of approx. 30 mm and the insulation of the stranded wires to a length of 7 mm min.
- PE-strand (6 mm²) of cable (1) and earthing cable (11) (4 mm²) are both to be crimped in a socket contact (10 mm²)
- Use crimp tool CWZ-600-1 and crimp stripped wire ends to the control contacts (5) and power contacts (6)
- Assemble the contact insert (3) with control contacts (5) and power contacts (6)
- Slide backshell (2) over contact insert (3) and screw those.
- Screw thread cable gland (2a) to backshell (2)

Assembly of cable receptacle

- Slide thread cable gland (OEM part) (2a) and backshell (2) on cable (1)
- Strip jacket of cable (1) to a length of approx. 30 mm and the insulation of the stranded wires to a length of 11 mm and 6 mm min., respectively.
- Solder stripped wire ends to the terminal ends of the contact insert
- in the receptacle shell (3)
- Screw receptacle shell with contact insert (3) into backshell (2)
- Screw thread cable gland (2a) to backshell (2)

Schaltbau GmbH

For detailed information on our products and services visit our website – or give us a call!

Schaltbau GmbH
Hollerithstrasse 5
81829 Munich
Germany



Phone +49 89 9 30 05-0
Fax +49 89 9 30 05-350
Internet www.schaltbau.com
e-Mail contact@schaltbau.de

with compliments:



The production facilities of Schaltbau GmbH have been IRIS certified since 2008.



Certified to DIN EN ISO 14001 since 2002. For the most recent certificate visit our website.



Certified to DIN EN ISO 9001 since 1994. For the most recent certificate visit our website.

Electrical Components and Systems for Railway Engineering and Industrial Applications

Connectors

- Connectors manufactured to industry standards
- Connectors to suit the special requirements of communications engineering (MIL connectors)
- Charging connectors for battery-powered machines and systems
- Connectors for railway engineering, including UIC connectors
- Special connectors to suit customer requirements

Snap-action switches

- Snap-action switches with positive opening operation
- Snap-action switches with self-cleaning contacts
- Enabling switches
- Special switches to suit customer requirements

Contactors

- Single and multi-pole DC contactors
- High-voltage AC/DC contactors
- Contactors for battery powered vehicles and power supplies
- Contactors for railway applications
- Terminal bolts and fuse holders
- DC emergency disconnect switches
- Special contactors to suit customer requirements

Electrics for rolling stock

- Equipment for driver's cab
- Equipment for passenger use
- High-voltage switchgear
- High-voltage heaters
- High-voltage roof equipment
- Equipment for electric brakes
- Design and engineering of train electrics to customer requirements