



W 160: Miniature series for optimum solutions



	Photoelectric proximity switches, BGB
	Photoelectric proximity switches, energetic
	Photoelectric reflex switches



optic cables with approx. 50 different configuration options are available as accessories.

W 160 switches have proven particularly successful in the following sectors:

- electronic component and printed circuit board production,
- the packaging and printing industries,
- assembly and handling systems,
- the construction of special-purpose machines, and
- conveyor systems.

	Through-beam photoelectric switches
	P/e switches w. fibre-optic cable (proximity mode)
	P/e switches w. fibre-optic cable (through-beam mode)

PPrincipal system characteristics are simple handling, large scanning ranges and a reduced number of sensor types thanks to integrated L.ON/D.ON switches. Integrated "intelligence" features such as pre-failure signalling output, test input (cable versions only) or external teach-in (WLL 160 T) increase system reliability under severe environmental conditions.

All W 160 optic variants are available in 2 housing versions with axial or 90° light emission. WLL 160 fibre-optic cable photoelectric switches with switching point adjustment (manual using potentiometers or automatic at the push of a button using the teach-in method) complete the W 160 series. LL 3 plastic fibre-

The scanning ranges:

- WS/WE 160 through-beam photoelectric switch: 7 m, slotted mask as accessory,
- WL 160 photoelectric reflex switch: 3 m (PL 80 A), with polarising filter,
- WT 160 photoelectric proximity switch: energetic: scanning distance up to 300 mm (90 % remission), for standard scanning tasks; with focused optics: scanning distance between 8 and 50 mm, background blanking, small light spot, high sensitivity; with divergent optics (angle of dispersion approx. 40°): scanning distance up to 80 mm; ideal for transparent objects.

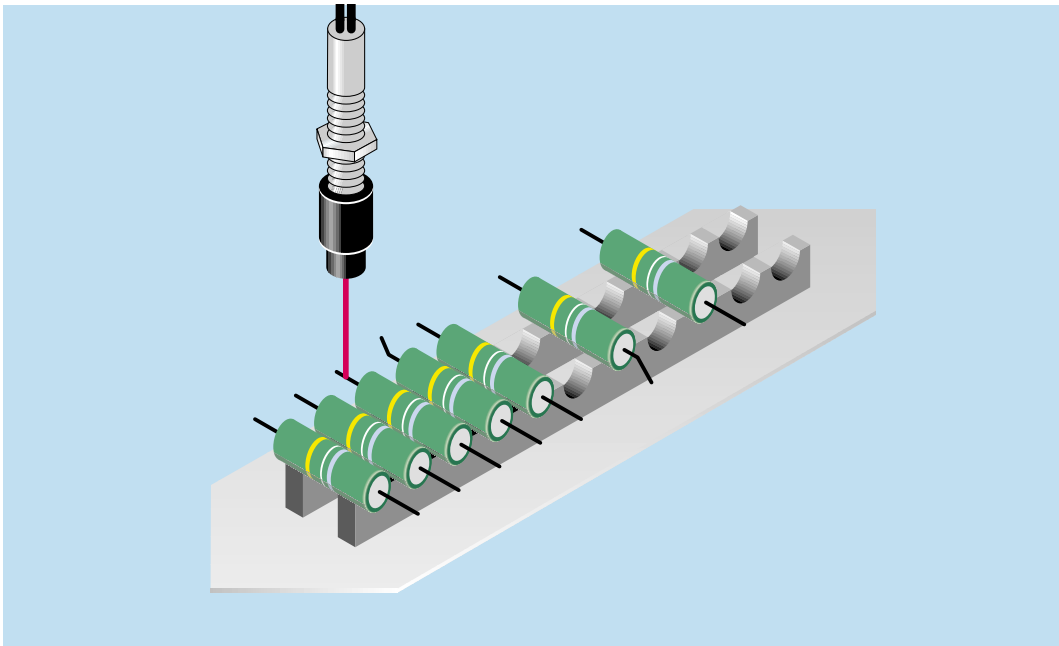

◀ Resistor production: fibre-optic WLL 160 switches can detect even the thinnest of wires without any problem.

▼ Checking the presence of caps and covers: Using a WT 160 photoelectric proximity switch to detect lids and WS/WE 160 through-beam photoelectric switches to monitor system timing.

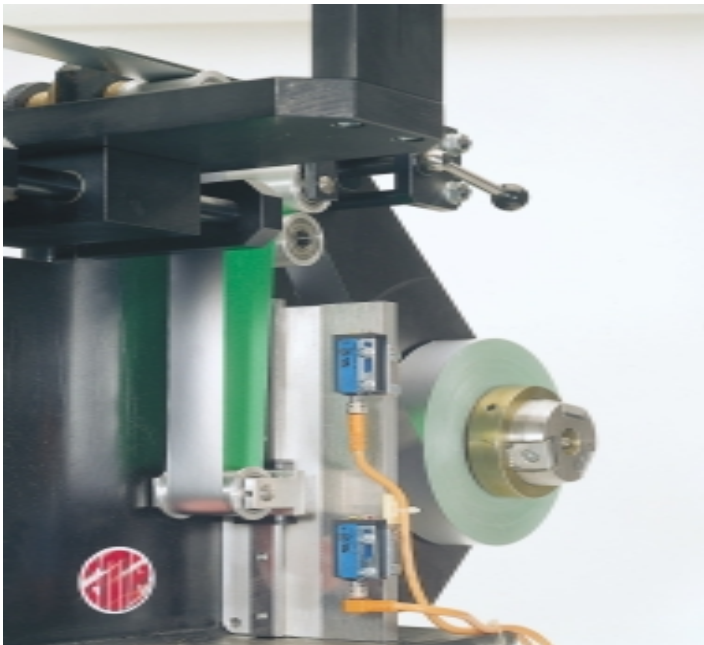

▲ The WT 160 miniature photoelectric proximity switch is used in film and foil processing to control feed tension.

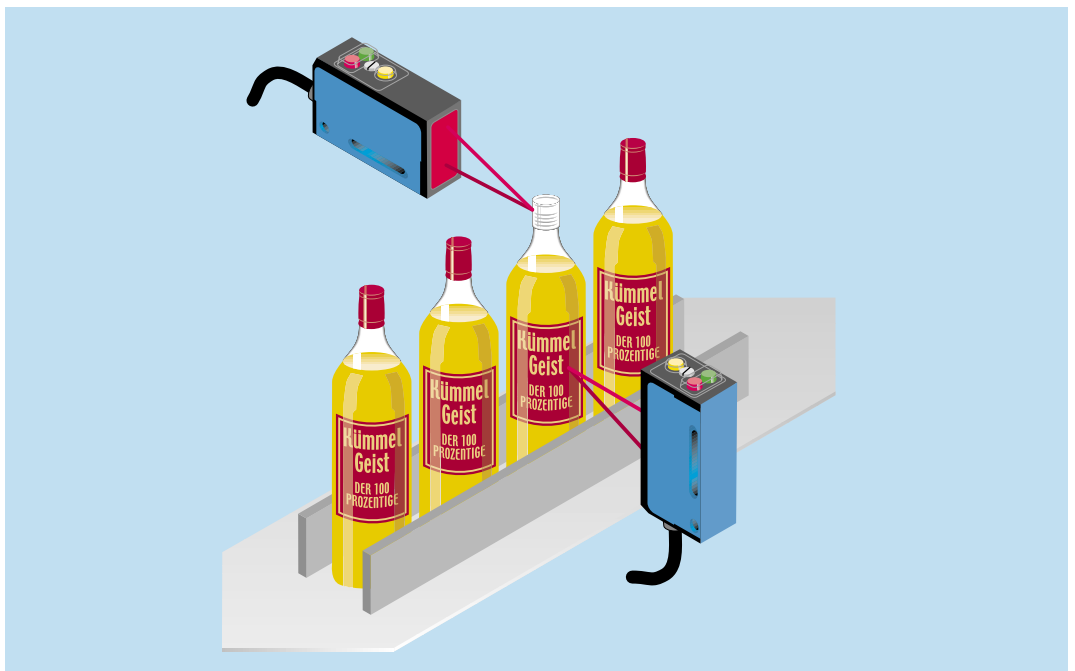
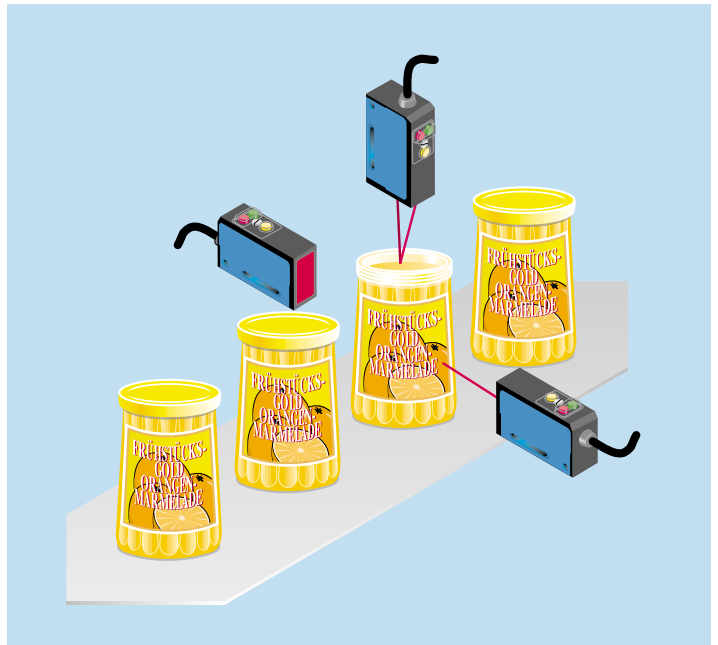

► Checking caps and labels using WT 160 photoelectric proximity switches.

Scanning distance
3...60 mm

Photoelectric proximity switches

- Horizontal and vertical models
- Focused scanner with background blanking and great sensitivity
- Contamination control with green LED indicator and pre-failure signalling output
- Test input for equipment and system testing

Dimensional drawing

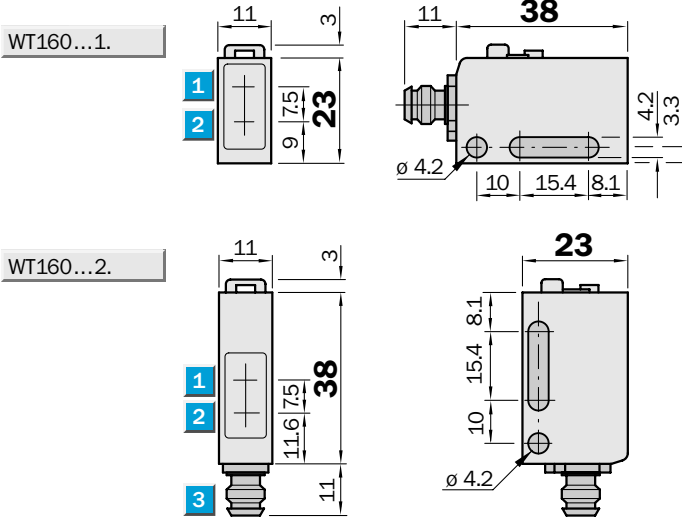

Adjustments possible

All types

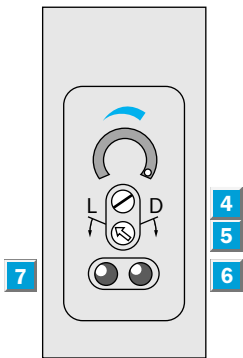

- 1 Centre of optical axis, receiver
- 2 Centre of optical axis, sender
- 3 Plug 4-pin, M 8 or connection cable
- 4 Sensitivity adjustment
- 5 Light/dark rotary switch:
L = light-switching
D = dark-switching
- 6 Red LED signal strength indicator
- 7 Green LED signal strength indicator

Connection types

WT 160-P 112	WT 160-P410
WT 160-N 112	WT 160-N410
WT 160-P 122	WT 160-P420
WT 160-N 122	WT 160-N420

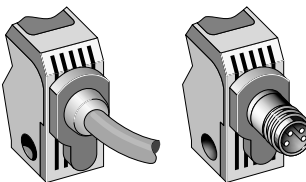

5 x 0.2 mm² 4-pin, M 8

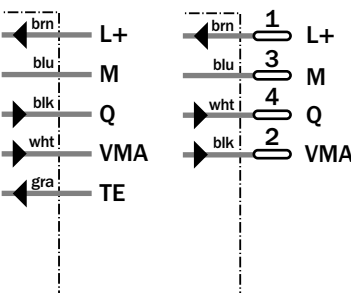

Operating diagram

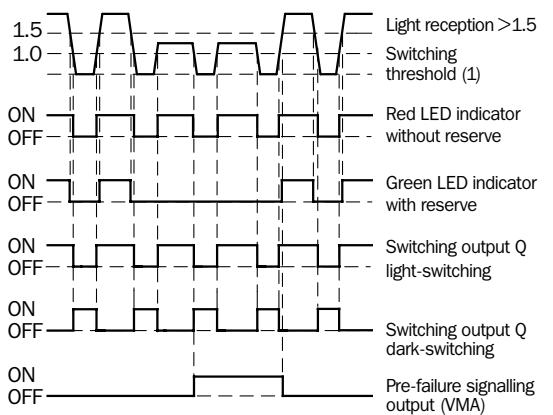

Accessories	page
Cable receptacles	496
Mounting brackets*	510

* included with delivery

Technical data		WT 160-	P 112	P 410	N 112	N 410	P 122	P 420	N 122	N 420
Housing design	Horizontal									
	Vertical									
Scanning distance, max. typical	3... 60 mm ¹⁾									
Operating distance	8... 50 mm ¹⁾									
Background blanking	From approx. 100 mm (background 90 % remission) ²⁾									
Adjustable sensitivity	Potentiometer, 2 turns with scaling 270°									
Light source ³⁾ , light type	LED, red light									
Light spot diameter	Approx. 3 mm at 25 mm									
Angle of dispersion, sender	Focused, focus 25 mm									
Supply voltage V_S	10...30 V DC ⁴⁾									
Ripple ⁵⁾	± 10 %									
Current consumption ⁶⁾	≤ 30 mA									
Switching outputs	PNP, open collector: Q NPN, open collector: Q									
Output current I_A max.	100 mA									
Light receiver, switching type	Light /dark-switching via rotary switch									
Response time ⁷⁾ /max. switching freq. ⁸⁾	≤ 0.9 ms / 550/s									
Pre-failure signalling output (VMA)	100 mA, static									
Test input "TE" ⁹⁾	Sender off; PNP: TE to +V Sender off; NPN: TE to 0V									
Connection types cable	PVC, 2 m ¹⁰⁾ ; 5 x 0.2 mm ² , ϕ 4.2 mm									
plug	4-pin, M8									
VDE protection class ¹¹⁾	□									
Circuit protection ¹²⁾	A, B, C, D									
Enclosure rating	IP 67									
Ambient temperature T_A	Operation - 25 °C...+ 55 °C Storage - 40 °C...+ 70 °C									
Weight	with cable: Approx. 60 g with plug: Approx. 20 g									
Housing material	Housing: ABS; optics: PC									

- | | | | |
|---|---|-------------------------------|--|
| 1) Scanned material with 90 % remission (based on standard white according to DIN 5033) | 4) Limit values | 8) With light/dark ratio 1:1 | 12) A = V_S connections reverse-polarity protected |
| 2) Average service life 100,000 h at $T_A = + 25 °C$ | 5) May not exceed or fall short of V_S tolerances | 9) TE not with plug model | B = Inputs and outputs reverse-polarity protected |
| 3) Background 90 % remission | 6) Without load | 10) Do not bend below 0 °C | C = Interference pulse suppression |
| | 7) Signal transit time with resistive load | 11) Reference voltage 50 V DC | D = Outputs overload and short-circuit protected |

Scanning distance

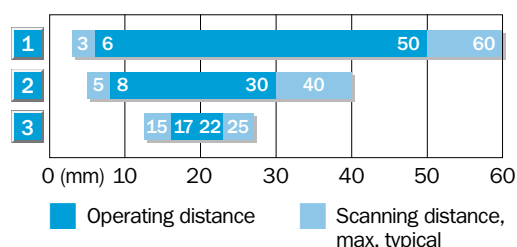

- | | |
|---|---|
| 1 | Scanning range on white, 90 % remission |
| 2 | Scanning range on gray, 18 % remission |
| 3 | Scanning range on black, 6 % remission |

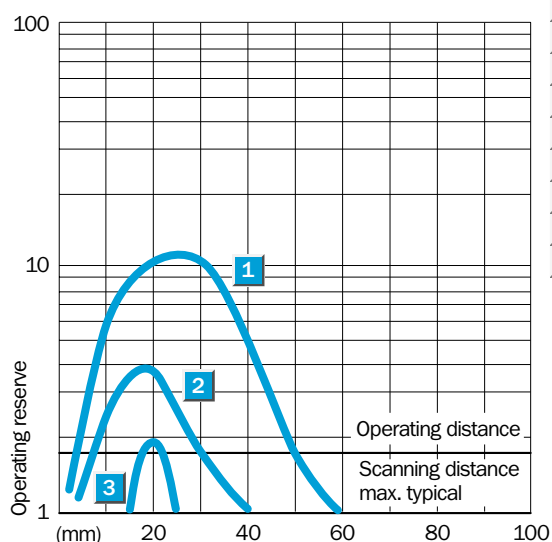

Order information

Type	Part no.
WT 160-P112	6 009 511
WT 160-P410	6 009 519
WT 160-N112	6 008 819
WT 160-N410	6 008 827
WT 160-P122	6 009 512
WT 160-P420	6 009 520
WT 160-N122	6 008 820
WT 160-N420	6 008 828

Scanning distance
0...360 mm
Photoelectric proximity switches

- Horizontal and vertical models
- Energetic scanner for standard applications
- Contamination control with green LED indicator and pre-failure signalling output
- Test input for device and system testing

Dimensional drawing

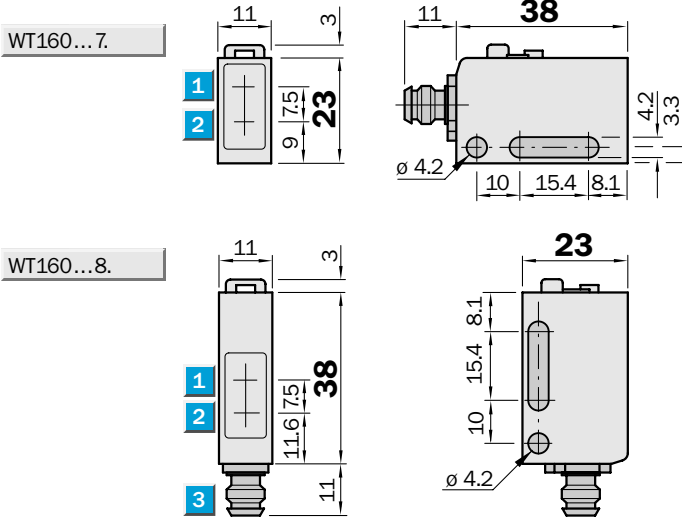

Adjustments possible

All types

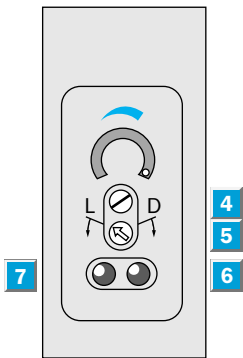

- 1 Centre of optical axis, receiver
- 2 Centre of optical axis, sender
- 3 Plug 4-pin, M8 or connection cable
- 4 Sensitivity adjustment
- 5 Light/dark rotary switch:
L = light-switching
D = dark-switching
- 6 Red LED signal strength indicator
- 7 Green LED signal strength indicator

Connection types

WT 160-P172	WT 160-P470
WT 160-N172	WT 160-N470
WT 160-P182	WT 160-P480
WT 160-N182	WT 160-N480

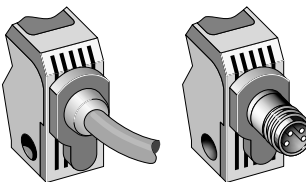

5x0.2 mm² 4-pin, M8

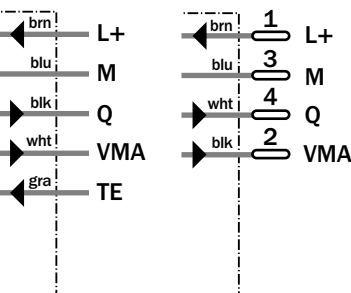

Operating diagram

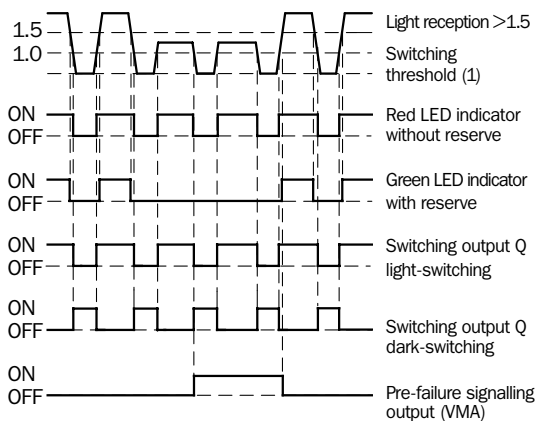

Accessories	page
Cable receptacles	496
Mounting brackets*	510

* included with delivery

Technical data		WT 160-	P172	P470	N172	N470	P182	P480	N182	N480
Housing design	Horizontal									
	Vertical									
Scanning distance, max. typical	0... 360 mm ¹⁾									
Operating distance	0... 300 mm ¹⁾									
Adjustable sensitivity	Potentiometer, 2 turns with scaling 270°									
Light source ²⁾ , light type	LED, red light									
Light spot diameter	Approx. 25 mm at 300 mm									
Angle of dispersion, sender	Approx. 4.8°									
Supply voltage V _S	10... 30 V DC ³⁾									
Ripple ⁴⁾	± 10 %									
Current consumption ⁵⁾	≤ 30 mA									
Switching outputs	PNP, open collector: Q NPN, open collector: Q									
Output current I _A max.	100 mA									
Light receiver, switching type	Light/dark-switching via rotary switch									
Response time ⁶⁾ /Max. switching freq. ⁷⁾	≤ 0.9 ms / 550/s									
Pre-failure signalling output (VMA)	100 mA, static									
Test input "TE" ⁸⁾	Sender off; PNP: TE to +V Sender off; NPN: TE to 0V									
Connection types cable	PVC, 2 m ⁹⁾ ; 5 x 0.2 mm ² , ∅ 4.2 mm									
plug	4-pin, M8									
VDE protection class ¹⁰⁾	□									
Circuit protection ¹¹⁾	A, B, C, D									
Enclosure rating	IP 67									
Ambient temperature T _A	Operation - 25 °C...+ 55 °C Storage - 40 °C...+ 70 °C									
Weight	with cable: Approx. 60 g with plug: Approx. 20 g									
Housing material	Housing: ABS; optics: PC									

- 1) Scanned material with 90 % remission (based on standard white according to DIN 5033)
- 2) Average service life 100,000 h at T_A = + 25 °C
- 3) Limit values
- 4) May not exceed or fall short of V_S tolerances
- 5) Without load
- 6) Signal transit time with resistive load
- 7) With light/dark ratio 1:1
- 8) TE not with plug model
- 9) Do not bend below 0 °C
- 10) Reference voltage 50 V DC
- 11) A = V_S connections reverse-polarity protected
B = Inputs and outputs reverse-polarity protected
C = Interference pulse suppression
D = Outputs overload and short-circuit protected

Scanning distance

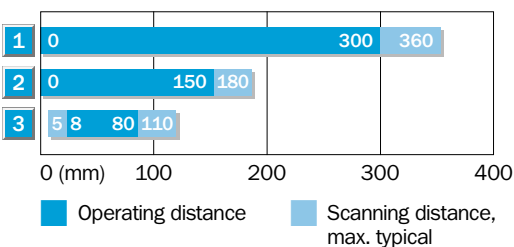

- 1 Scanning range on white, 90 % remission
- 2 Scanning range on gray, 18 % remission
- 3 Scanning range on black, 6 % remission

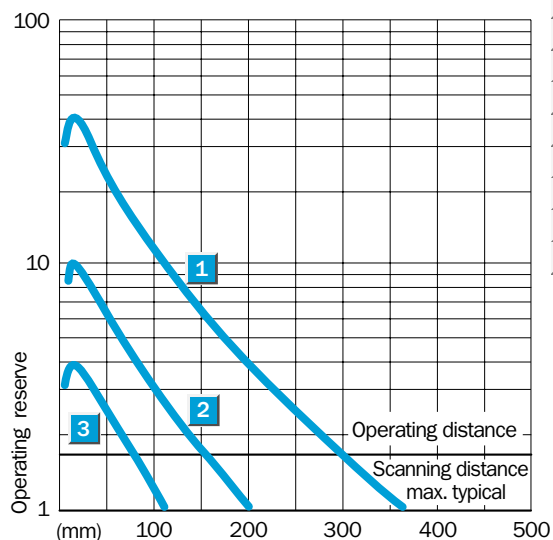

Order information

Type	Part no.
WT 160-P172	6 009 517
WT 160-P470	6 009 525
WT 160-N172	6 008 825
WT 160-N470	6 008 833
WT 160-P182	6 009 518
WT 160-P480	6 009 526
WT 160-N182	6 008 826
WT 160-N480	6 008 834

Scanning distance
0...100 mm

Photoelectric proximity switches

- Horizontal and vertical models
- Scanner with large aperture angle for greater tolerances of target position
- Contamination control with green LED indicator and pre-failure signalling output
- Test input for device and system testing

Dimensional drawing

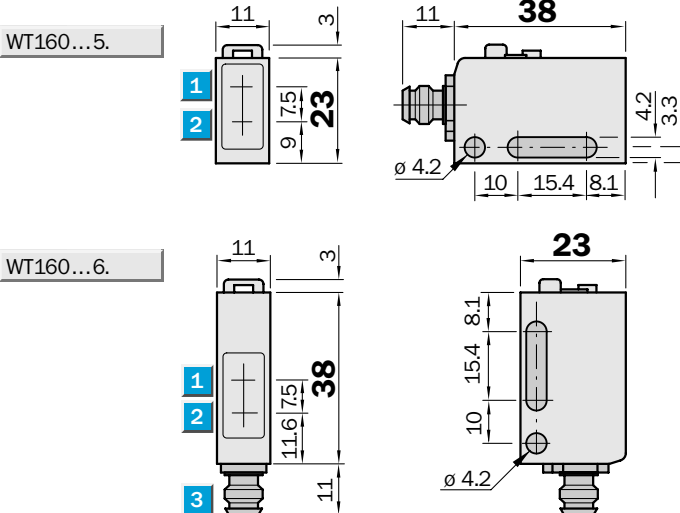

Adjustments possible

All types

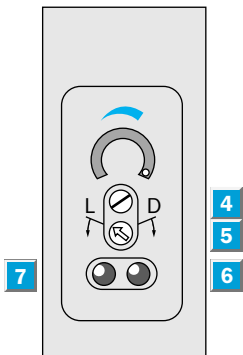

- 1 Centre of optical axis, receiver
- 2 Centre of optical axis, sender
- 3 Plug 4-pin, M 8 or connection cable
- 4 Sensitivity adjustment
- 5 Light/dark rotary switch:
L = light-switching
D = dark-switching
- 6 Red LED signal strength indicator
- 7 Green LED signal strength indicator

Connection type

WT 160-P 152	WT 160-P450
WT 160-N152	WT 160-N450
WT 160-P 162	WT 160-P460
WT 160-N162	WT 160-N460

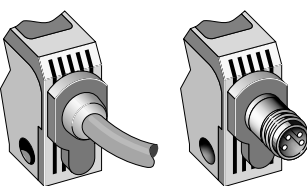

5x0.2 mm² 4-pin, M8

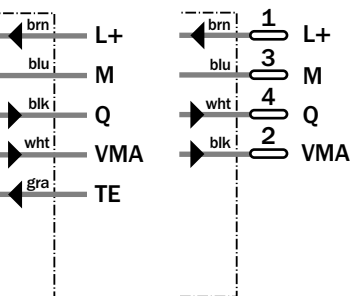

Operating diagram

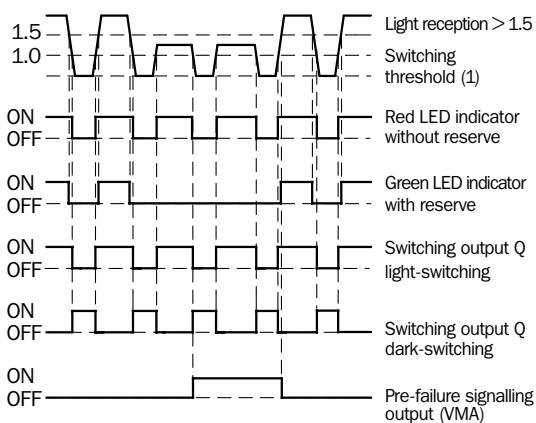

Accessories	page
Cable receptacles	496
Mounting brackets*	510

* included with delivery

Technical data		WT 160-	P 152	P 450	N 152	N 450	P 162	P 460	N 162	N 460
Housing design	Horizontal									
	Vertical									
Scanning distance, max. typical	0...100 mm ¹⁾²⁾									
Operating distance	0...80 mm ¹⁾²⁾									
Adjustable sensitivity	Potentiometer, 2 turns with scaling 270°									
Light source ³⁾ , light type	LED, infrared light									
Light spot diameter	Approx. 60 mm at 80 mm									
Angle of dispersion, sender	Approx. 40°									
Supply voltage V_S	10...30 V DC ⁴⁾									
Ripple ⁵⁾	± 10 %									
Current consumption ⁶⁾	≤ 30 mA									
Switching outputs	PNP, open collector: Q NPN, open collector: Q									
Output current I_A max.	100 mA									
Light receiver, switching type	Light/dark-switching via rotary switch									
Response time ⁷⁾ /max. switching freq. ⁸⁾	≤ 0.9 ms/550/s									
Pre-failure signalling output (VMA)	100 mA, static									
Test input "TE" ⁹⁾	Sender off; PNP: TE to +V Sender off; NPN: TE to 0V									
Connection type cable	PVC, 2 m ¹⁰⁾ ; 5 x 0.2 mm ² , ϕ 4.2 mm									
plug	4-pin, M8									
VDE protection class ¹¹⁾	□									
Circuit protection ¹²⁾	A, B, C, D									
Enclosure rating	IP 67									
Ambient temperature T_A	Operation -25 °C...+55 °C Stockage -40 °C...+70 °C									
Weight	with cable: Approx. 60 g with plug: Approx. 20 g									
Housing material	Housing: ABS; optics: PCC									

- 1) Scanned material with 90 % remission (based on standard white according to DIN 5033)
- 2) Object size 30 x 30 mm
- 3) Average service life 100,000 h at $T_A = +25 °C$
- 4) Limit values
- 5) May not exceed or fall short of V_S tolerances
- 6) Without load
- 7) Signal transit time with resistive load
- 8) With light/dark ratio 1:1
- 9) TE not with plug model
- 10) Do not bend below 0 °C
- 11) Reference voltage 50 V DC
- 12) A = V_S connections reverse-polarity protected
B = Inputs and outputs reverse-polarity protected
C = Interference pulse suppression
D = Outputs overload and short-circuit protected

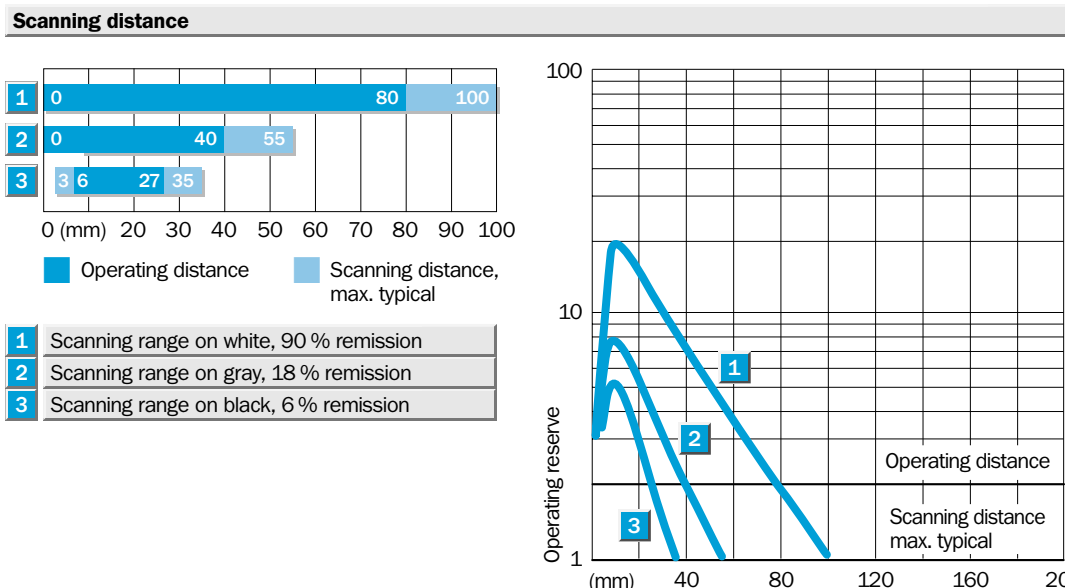

Order information

Type	Part no.
WT 160-P152	6 009 515
WT 160-P450	6 009 523
WT 160-N152	6 008 823
WT 160-N450	6 008 831
WT 160-P162	6 009 516
WT 160-P460	6 009 524
WT 160-N162	6 008 824
WT 160-N460	6 008 832

Scanning range
0.01... 3 m
Photoelectric reflex switches

- Horizontal and vertical models
- Polarisation filter for detection of object with reflective surfaces
- Contamination control with green LED indicator and pre-failure signalling output
- Test input for device and system testing

Dimensional drawing

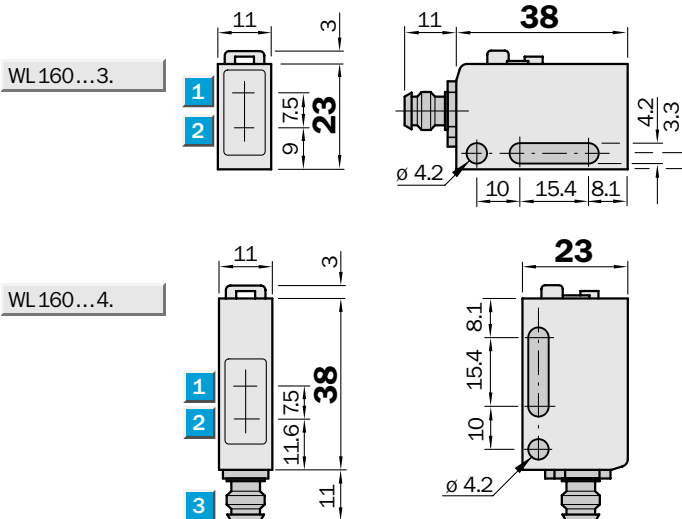

Adjustments possible

All types

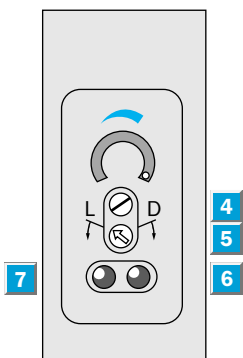

- 1 Centre of optical axis, receiver
- 2 Centre of optical axis, sender
- 3 Plug 4-pin, M 8 or connection cable
- 4 Sensitivity adjustment
- 5 Light/dark rotary switch:
L = light-switching
D = dark-switching
- 6 Red LED signal strength indicator
- 7 Green LED signal strength indicator

Connection types

WL 160-P132	WL 160-P430
WL 160-N132	WL 160-N430
WL 160-P142	WL 160-P440
WL 160-N142	WL 160-N440

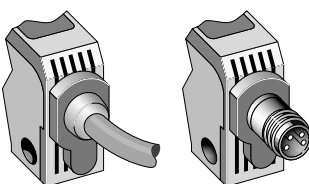

5 x 0.2 mm² 4-pin, M8

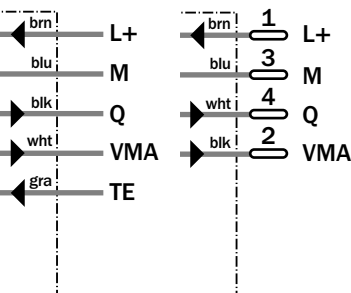

Operating diagram

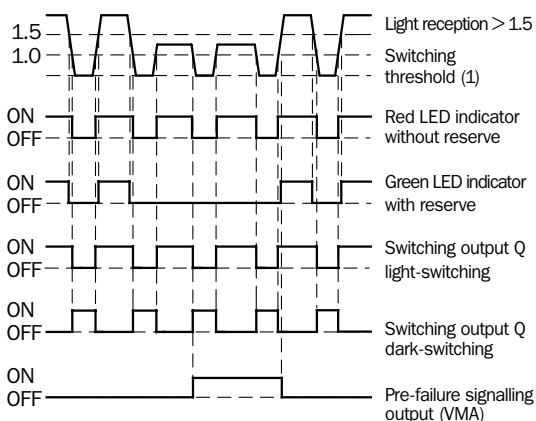

Accessories	page
Cable receptacles	496
Mounting brackets*	510
Reflectors**	520

* included with delivery
 ** Reflector P 250 included with delivery

Technical data		WL 160-	P 132	P 430	N 132	N 430	P 142	P 440	N 142	N 440
Housing design	Horizontal									
	Vertical									
Scanning range, max. typical/on refl.	0.01...3 m/PL80A									
	max. typical/on refl. 0.005...2.4 m/P 250 (included)									
Operating range	0.01...2.0 m/P250									
Adjustable sensitivity	Potentiometer, 2 turns with scaling 270°									
Light source ¹⁾ , light type	LED, red light with polarising filter									
Light spot diameter	Approx. 150 mm at 2.0 m									
Angle of dispersion, sender	Approx. 4.5°									
Supply voltage V_S	10...30 V DC ²⁾									
Ripple ³⁾	± 10 %									
Current consumption ⁴⁾	≤ 30 mA									
Switching outputs	PNP, open collector: Q									
	NPN, open collector: Q									
Output current I_A max.	100 mA									
Light receiver, switching type	Light/dark-switching via rotary switch									
Response time ⁵⁾ /max. switching freq. ⁶⁾	≤ 0.9 ms / 550/s									
Pre-failure signalling output (VMA)	100 mA, static									
Test input "TE" ⁷⁾	Sender off; PNP: TE to +V									
	Sender off; NPN: TE to 0V									
Connection types cable	PVC, 2 m ⁸⁾ ; 5 x 0.2 mm ² , Ø 4.2 mm									
	plug	4-pin, M8								
VDE protection class ⁹⁾	□									
Circuit protection ¹⁰⁾	A, B, C, D									
Enclosure rating	IP 67									
Ambient temperature T_A	Operation - 25 °C...+ 55 °C									
	Storage - 40 °C...+ 70 °C									
Weight	with cable	Approx. 60 g								
	with plug	Approx. 20 g								
Housing material	Housing: ABS; optics: PMMA									

1) Average service life 100,000 h at $T_A = + 25 °C$
 2) Limit values

3) May not exceed or fall short of V_S tolerances
 4) Without load
 5) Signal transit time with resistive load

6) With light/dark ratio 1:1
 7) TE not with plug model
 8) Do not bend below 0 °C
 9) Reference voltage 50 V DC

10) A = V_S connections reverse-polarity protected
 B = Inputs and outputs reverse-polarity protected
 C = Interference pulse suppression
 D = Outputs overload and short-circuit protected

Scanning range and operating reserve

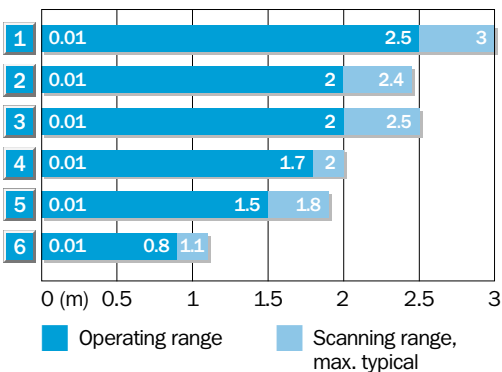

Reflector type	Operating range
1 PL 80 A	0.01...2.5 m
2 P 250	0.01...2.0 m
3 PL 50 A/PL 40 A	0.01...2.0 m
4 PL 30 A/PL 31 A	0.01...1.7 m
5 PL 20 A	0.01...1.5 m
6 Reflective tape Diamond Grade	0.01...0.8 m

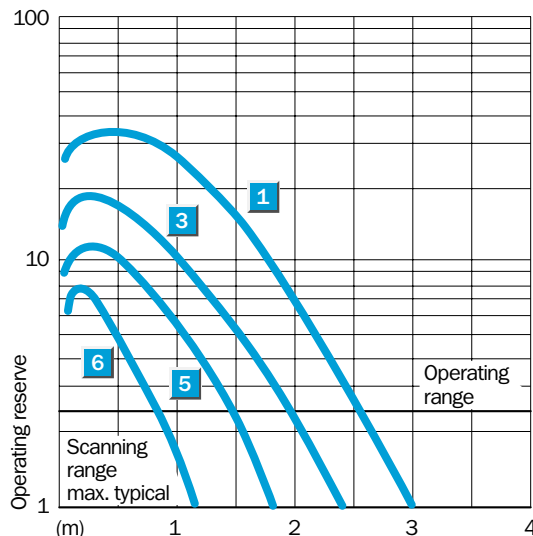

Order information

Type	Part no.
WL 160-P132	6 008 813
WL 160-P430	6 008 815
WL 160-N132	6 008 807
WL 160-N430	6 008 809
WL 160-P142	6 008 814
WL 160-P440	6 008 816
WL 160-N142	6 008 808
WL 160-N440	6 008 810

Scanning range
8.5 m

Through-beam photoelectric switches

- Horizontal and vertical models
- Slotted masks for increasing switching frequency
- Contamination control with green LED indicator and pre-failure signalling output
- Test input for device and system testing



Dimensional drawing

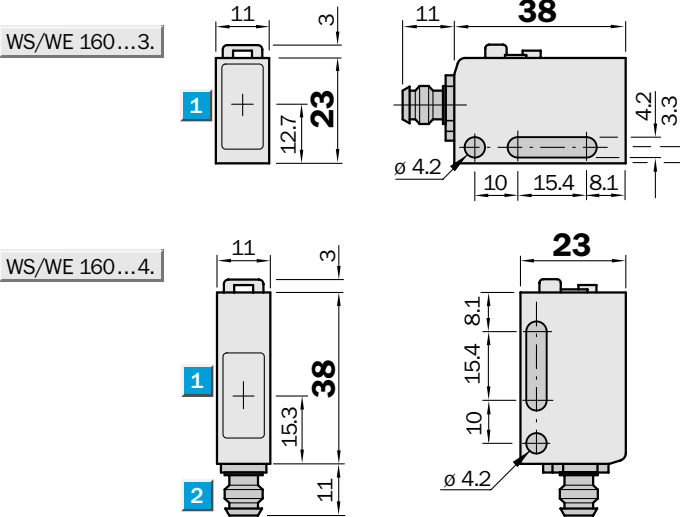

Adjustments possible

All types

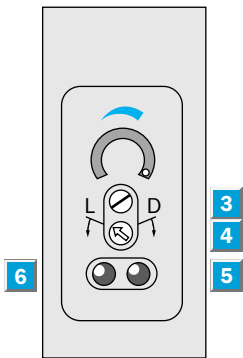

- Centre of optical axis sender/receiver
- Plug 4-pin, M 8 or connection cable
- Light/dark rotary switch:
L = light-switching
D = dark-switching
- Sensitivity adjustment
- Indicator, red (sender WS active)
- Green LED signal strength indicator (receiver WE)

Connection types

WS/WE160-P132	WS/WE160-P430
WS/WE160-N132	WS/WE160-N430
WS/WE160-P142	WS/WE160-P440
WS/WE160-N142	WS/WE160-N440

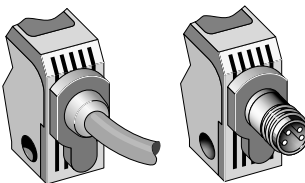

3 x 0.2 mm²

4-pin, M 8

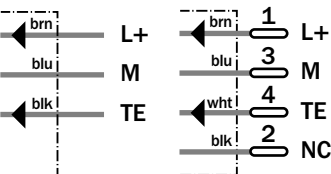

4 x 0.2 mm²

4-pin, M 8

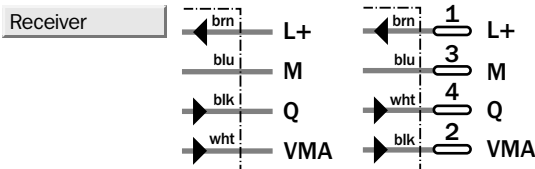

Operating diagram

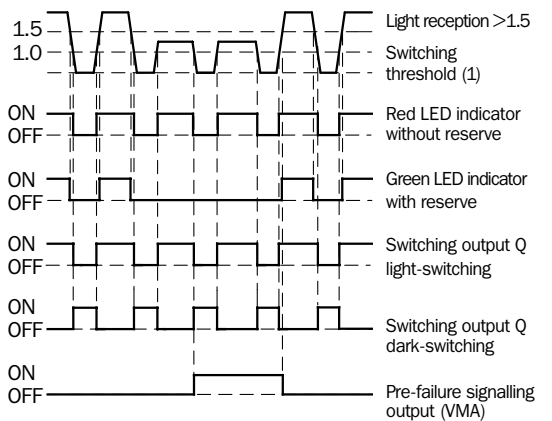

Accessories	page
Cable receptacles	496
Mounting brackets*	510
Slotted mask	556

* included with delivery



Technical data		WS/WE160-	P132	P430	N132	N430	P142	P440	N142	N440
Housing design	Horizontal									
	Vertical									
Scanning range, max. typical	0...8.5 m									
Operating range	0...7 m									
Operating range with filter, width 1.0 m	0...1 m									
Adjustable sensitivity	Potentiometer, 2 turns with scaling 270°									
Light source ¹⁾ , light type	LED, infrared light									
Light spot diameter	Approx. 400 mm at 7 m									
Angle of dispersion, sender	Approx. 3.3°									
Angle of dispersion, receiver	Approx. 15°									
Supply voltage V_S	10...30 V DC ²⁾									
Ripple ³⁾	± 10 %									
Current consumption ⁴⁾	sender	≤ 20 mA								
	receiver	≤ 30 mA								
Switching outputs	PNP, open collector: Q									
	NPN, open collector: Q									
Output current I_A max.	100 mA									
Light receiver, switching type	Light/dark-switching via rotary switch									
Response time ⁵⁾ /max. switching freq. ⁶⁾	≤ 1.5 ms / 300/s									
Pre-failure signalling output (VMA)	100 mA, static									
Test input "TE" ⁷⁾	Sender off: TE to 0 V									
Connection types cable	PVC, 2 m ⁸⁾									
	sender WS	3 x 0.2 mm ² , Ø 4.2 mm								
	receiver WE	4 x 0.2 mm ² , Ø 4.2 mm								
	plug	4-pin, M8								
VDE protection class ⁹⁾	□									
Circuit protection ¹⁰⁾	sender WS	A, B								
	receiver WS	A, B, C, D								
Enclosure rating	IP 67									
Ambient temperature T_A	Operation	-25 °C...+55 °C								
	Storage	-40 °C...+70 °C								
Weight	with cable	Sender/receiver each approx. 60 g								
	with plug	Sender/receiver each approx. 20 g								
Housing material	Housing: ABS; optics: PC									

- 1) Average service life 100,000 h at $T_A = +25 °C$
- 2) Limit values
- 3) May not exceed or fall short of V_S tolerances
- 4) Without load

- 5) Signal transit time with resistive load
- 6) With light/dark ratio 1:1
- 7) TE not with plug model
- 8) Do not bend below 0 °C
- 9) Reference voltage 50 V DC

- 10) A = V_S connections reverse-polarity protected
- B = Inputs and outputs reverse-polarity protected
- C = Interference pulse suppression
- D = Outputs overload and short-circuit protected

- 11) Part no. includes transmitter and receiver

Scanning range and operating reserve

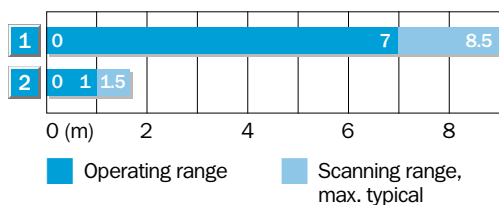

- 1 Without slotted mask
- 2 With slotted mask 1 mm, BL-160-10

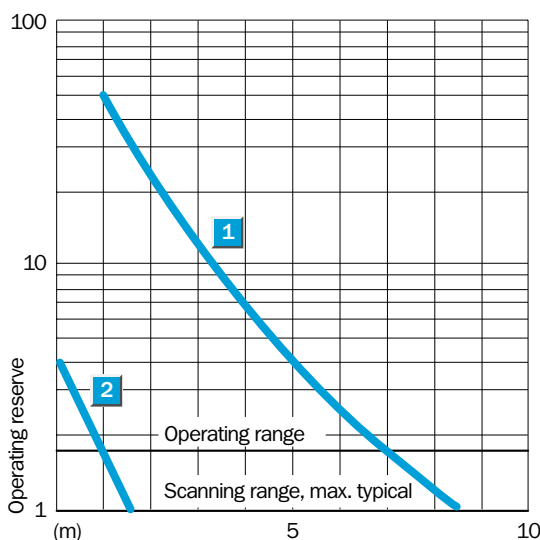

Order information

Type	Part no. ¹¹⁾
WS/WE160-P132	6 009 555
WS/WE160-P430	6 009 557
WS/WE160-N132	6 009 549
WS/WE160-N430	6 009 551
WS/WE160-P142	6 009 556
WS/WE160-P440	6 009 558
WS/WE160-N142	6 009 550
WS/WE160-N440	6 009 552

	Scanning range max. 2 m
Through-beam systems	
	Scanning distance max. 70 mm
Proximity systems	

- Sensitivity adjustment with potentiometer, scaled
- Large selection of LL3 fibre-optic cables (accessories)
- Off-delay 0...100 ms
- Pre-failure signalling output and test input for device and system testing

Dimensional drawing

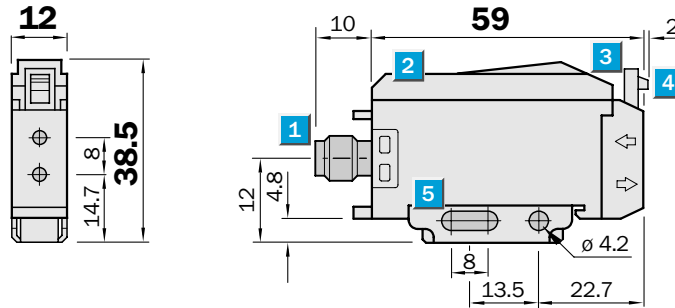

Adjustments possible

All types

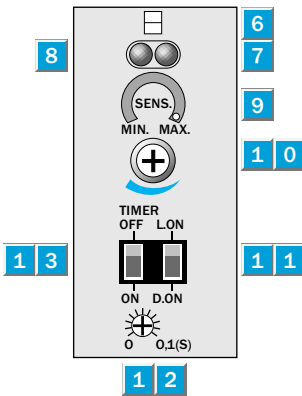

- 1** Plug 4-pin, M8 or connection cable
- 2** Protective hood
- 3** Fibre-optic cable lock (press down)
- 4** Fibre-optic cable release (press lug)
- 5** Mounting bracket, supplied with equipment
- 6** Indication of correct fibre-optic cable mounting
- 7** Red LED signal strength indicator (lights when switching threshold is exceeded)
- 8** Green LED signal strength indicator (lights when operating reserve is exceeded > 1.3)
- 9** Sensitivity scale
- 1 0** Sensitivity switch (4 turns)
- 1 1** Light-/dark-switching
- 1 2** OFF-delay 0...100 ms
- 1 3** Time delay on/off switch



Connection types

WLL 160-F 122	WLL 160-F 420
WLL 160-E 122	WLL 160-E 420

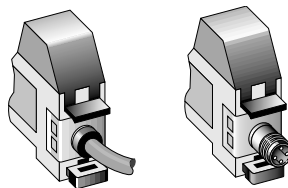

5 x 0.18 mm² 4-pin, M8

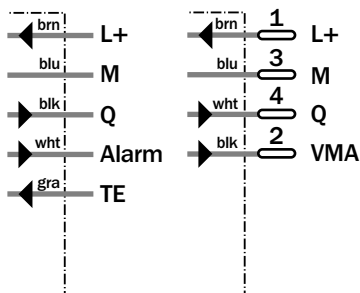

Operating diagram

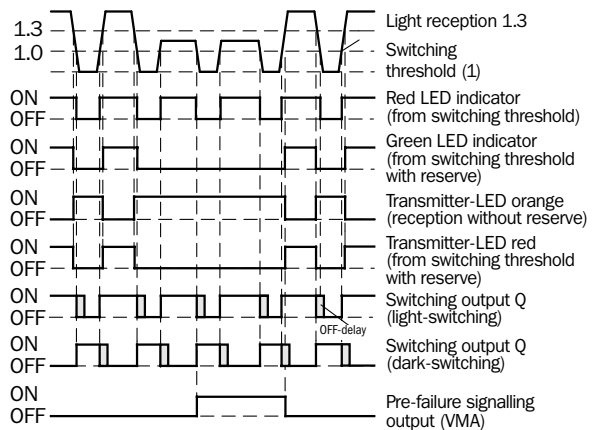

Accessories	page
Cable receptacles	496
Mounting brackets*	510
LL 3 fibre-optic cables	528

* included with delivery

Technical data		WLL160-	F122	F420	E122	E420						
Suitable fibre-optic cables	LL 3 plastic fibre-optic cable series (p. 528)											
Scanning ranges	Depend. on fibre-optic cable type used											
Scanning range, through-beam system	0...500 mm (with tip adapter 0...2 m)											
Scanning distance, scanner system	0...70 mm ¹⁾											
Adjustable sensitivity	Potentiometer, 4 turns with scaling 270°											
Light source²⁾, light type												
Light reception with operating reserve	LED, visible red light ("spot control")											
Light reception without operating reserve	LED, visible red-orange light ("spot control")											
Light spot diameter	Dependent on scanning range											
Opening angle of fibre-optic cables	Approx. 65°											
Supply voltage V_S												
	10...30 V DC ³⁾											
Ripple ⁴⁾	± 10 %											
Current consumption ⁵⁾	≤ 30 mA											
Switching outputs												
	PNP, open collector: Q											
	NPN, open collector: Q											
Output current I _A max.	100 mA											
Light receiver, switching type	Light /dark-switching via slide switch											
Response time ⁶⁾ /max. switching freq. ⁷⁾	≤ 0.35 ms / 1500/s											
Pre-failure signalling output (VMA)	100 mA, static											
Test input "TE"⁸⁾												
	Sender off; PNP: TE to +V											
	Sender off; NPN: TE to 0V											
Time delay T_{OFF} (OFF-delay)	Selectable, per slide switch											
Time range	Adjust., 0...100 ms; potentiometer 270°											
Connection types												
cable	PVC, 2m ⁹⁾ ; 5 x 0.2 mm ² , ø 4.2 mm											
plug	4-pin, M8											
VDE protection class¹⁰⁾												
	□											
Circuit protection ¹¹⁾	A, B, C, D											
Enclosure rating												
	IP 66											
Ambient temperature T_A												
	Operation - 25 °C...+ 55 °C											
	Storage - 40 °C...+ 70 °C											
Weight												
with cable	Approx. 80 g											
with plug	Approx. 30 g											
Housing material												
	ABS											

1) Scanned material with 90 % remission (based on standard white according to DIN 5033)

2) Average service life 100,000 h at T_A = + 25 °C

3) Limit values

4) May not exceed or fall short of V_S tolerances

5) Without load

6) Signal transit time with resistive load

7) With light/dark ratio 1:1

8) TE not with plug model

9) Do not bend below 0 °C

10) Reference voltage 50 V DC

11) A = V_S connections reverse-polarity protected



B = Inputs and outputs reverse-polarity protected

C = Interference pulse suppression

D = Outputs overload and short-circuit protected

Order information

Type	Part no.
WLL160-F122	6 009 989
WLL160-E122	6 009 981
WLL160-F420	6 009 990
WLL160-E420	6 009 982

	Scanning range max. 2 m
Through-beam systems	
	Scanning distance max. 70 mm
Proximity systems	

- Automatic setting of the switching threshold and hysteresis with teach-in via button or external control cable ET
- Large selection of LL 3 plastic fibre-optic cables (accessories)
- Switching frequency 830/s or 1660/s, switchable

Dimensional drawing

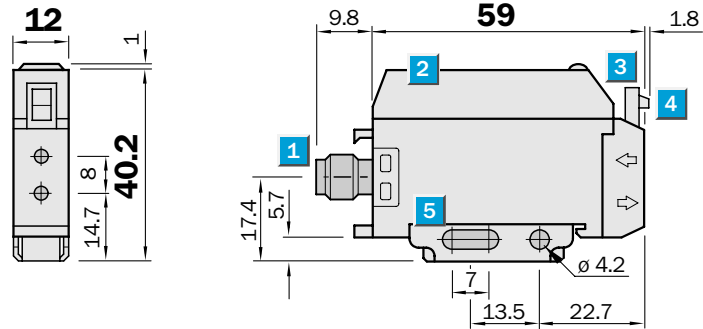

Adjustments possible

All types

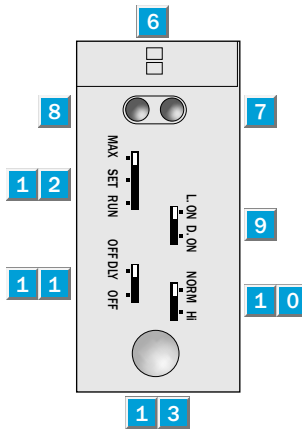

- 1** Plug 4-pin, M8 or connection cable
- 2** Protective hood
- 3** Fibre-optic cable lock (press down)
- 4** Fibre-optic cable release (press lug)
- 5** Mounting bracket, supplied with equipment
- 6** Indication of correct fibre-optic cable mounting
- 7** LED signal strength indicator, red (lights when switching threshold is exceeded)
- 8** LED signal strength indicator, green
- 9** Selector switch light- ("L.ON")/dark-switching ("D.ON")
- 1 0** Selector switch response time, NORM (600 µs)/HI (300 µs)
- 1 1** Selector switch OFF-delay On ("OFF DLY")/off ("OFF"); 40 ms fix
- 1 2** Operating mode selector switch "MAX/SET/RUN"
- 1 3** Teach-in button



Connection types

WLL 160T-F132	WLL 160T-F430
WLL 160T-E132	WLL 160T-E430

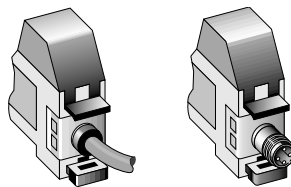

5x0.18 mm² 4-pin, M8

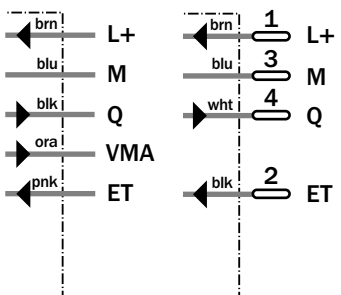

Operating diagram

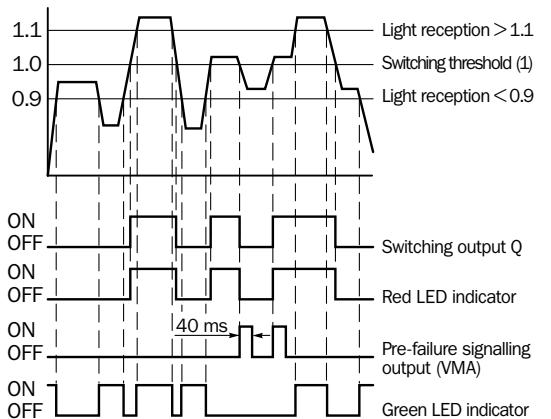

Accessories	page
Cable receptacles	496
Mounting brackets*	510
LL 3 fibre-optic cables	528

* included with delivery

Technical data		WLL 160T-	F132	F430	E132	E430						
Suitable fibre-optic cables	LL 3 plastic fibre-optic cable series (p. 528)											
Scanning ranges	Depend. on fibre-optic cable type used											
Scanning range, through-beam system	0...500 mm (with tip adapter 0...2 m)											
Scanning distance, scanner system	0...70 mm ¹⁾											
Adjustable sensitivity	Automatic, via TEACH-IN key or "MAX" mode											
Mode selector switch "MAX" position	Max. range, set permanently											
"SET" position	TEACH-IN key activated											
"RUN" position	TEACH-IN key inactive, equipment in sensor mode											
TEACH-IN manual	Via button (only active if mode switch is in "SET" position)											
external TEACH-IN	Only active, if mode switch is in "RUN" position PNP: control wire + V NPN: control wire 0 V											
Light source²⁾, light type	LED, visible red light											
Light spot diameter	Dependent on range											
Opening angle of fibre-optic cables	Approx. 65°											
Supply voltage V_S	10...24 V DC											
Ripple ³⁾	≤ 5 V _{SS}											
Current consumption ⁴⁾	≤ 50 mA											
Switching outputs	PNP, open collector: Q NPN, open collector: Q											
Output current I _A max.	100 mA											
Light receiver, switching type	Light-/dark-switching via slide switch											
Response time ^{5)/} max. switching freq. ⁶⁾	≤ 0.6 ms/830/s, selectable											
Dependent on selected operating mode: "Mode"-selector switch in pos. "MAX" or selector switch "Response time" in "NORM" position												
Selector "response time" in pos. "HI"	≤ 0.3 ms/1660/s ⁷⁾											
Pre-failure signalling output (VMA)	30 mA, one shot, pulse length 40 ms											
Time delay T_{OFF} (switch-off delay)	40 ms fixed, selectable, per slide switch											
Connection types cable	PVC, 2 m ⁸⁾ ; 5 x 0.18 mm ² , ø 4.0 mm											
plug	4-pin, M8											
VDE protection class⁹⁾	□											
Circuit protection ¹⁰⁾	A, B, C, D											
Enclosure rating	IP 66											
Ambient temperature T_A	Operation -25 °C...+55 °C Storage -40 °C...+70 °C											
Weight with cable	Approx. 80 g											
with plug	Approx. 30 g											
Housing material	Housing: ABS											

1) Scanned material with 90 % remission
(based on standard white according to
DIN 5033)

2) Average service life 100.000 h
at T_A = +25 °C

3) May not exceed or fall short
of V_S tolerances

4) Without load

5) Signal transit period with resistive load

6) With light/dark ratio 1:1

7) Scanning distance reduction
approx. 30 %

8) Do not bend below 0° C

9) Reference voltage 50 V DC

10) A = V_S connections reverse-polarity
protected

B = Inputs and outputs reverse-
polarity protected

C = Interference pulse suppression

D = Outputs overload and short-circuit
protected

Order information

Type	Part no.
WLL 160T-F132	6 010 650
WLL 160T-F430	6 010 651
WLL 160T-E132	6 010 648
WLL 160T-E430	6 010 649

1. Precise sensitivity setting (via 2x push of button); WLL 160T

TEACH-IN steps

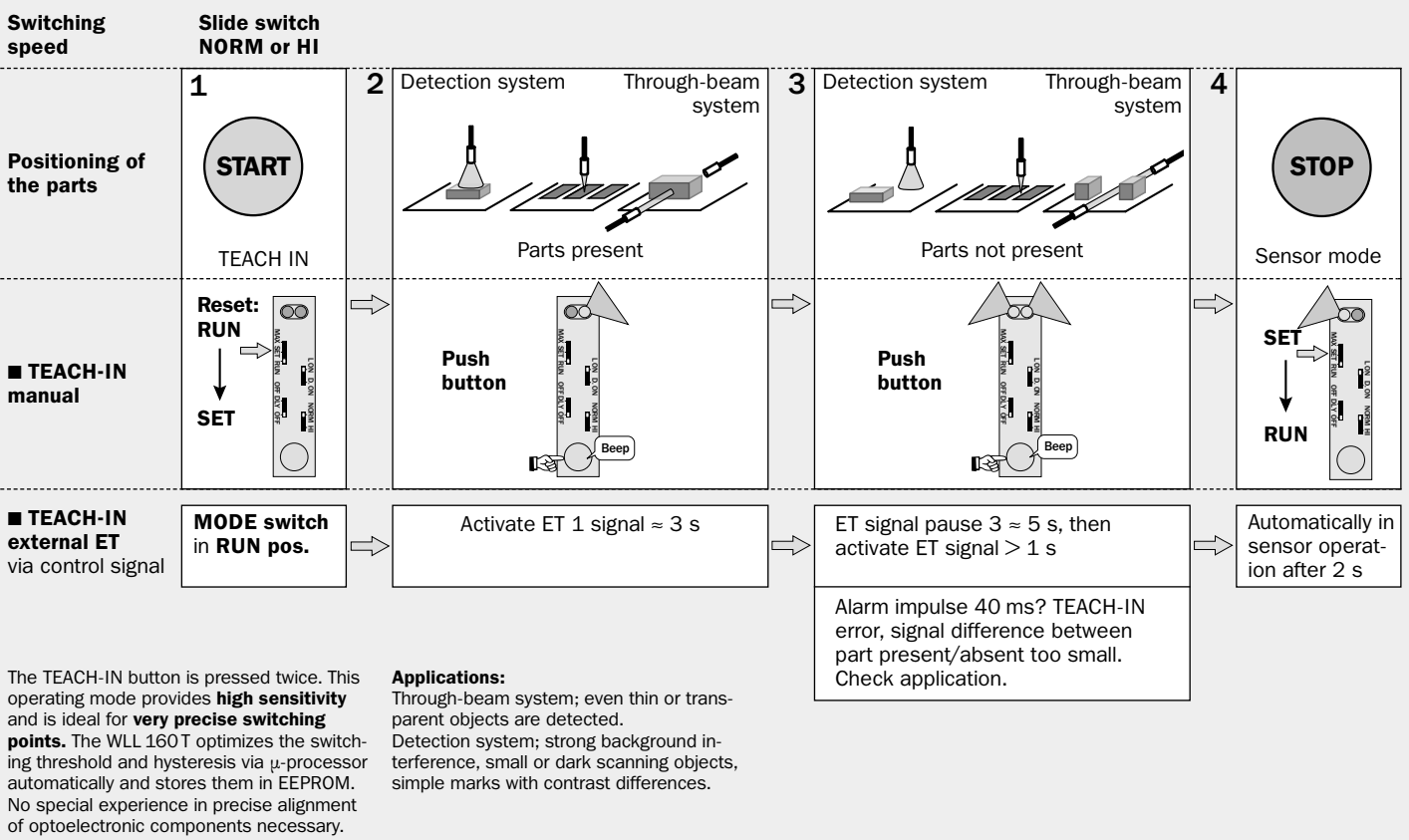

2. Simple sensitivity setting (via 1x push of button); WLL 160T

TEACH-IN steps

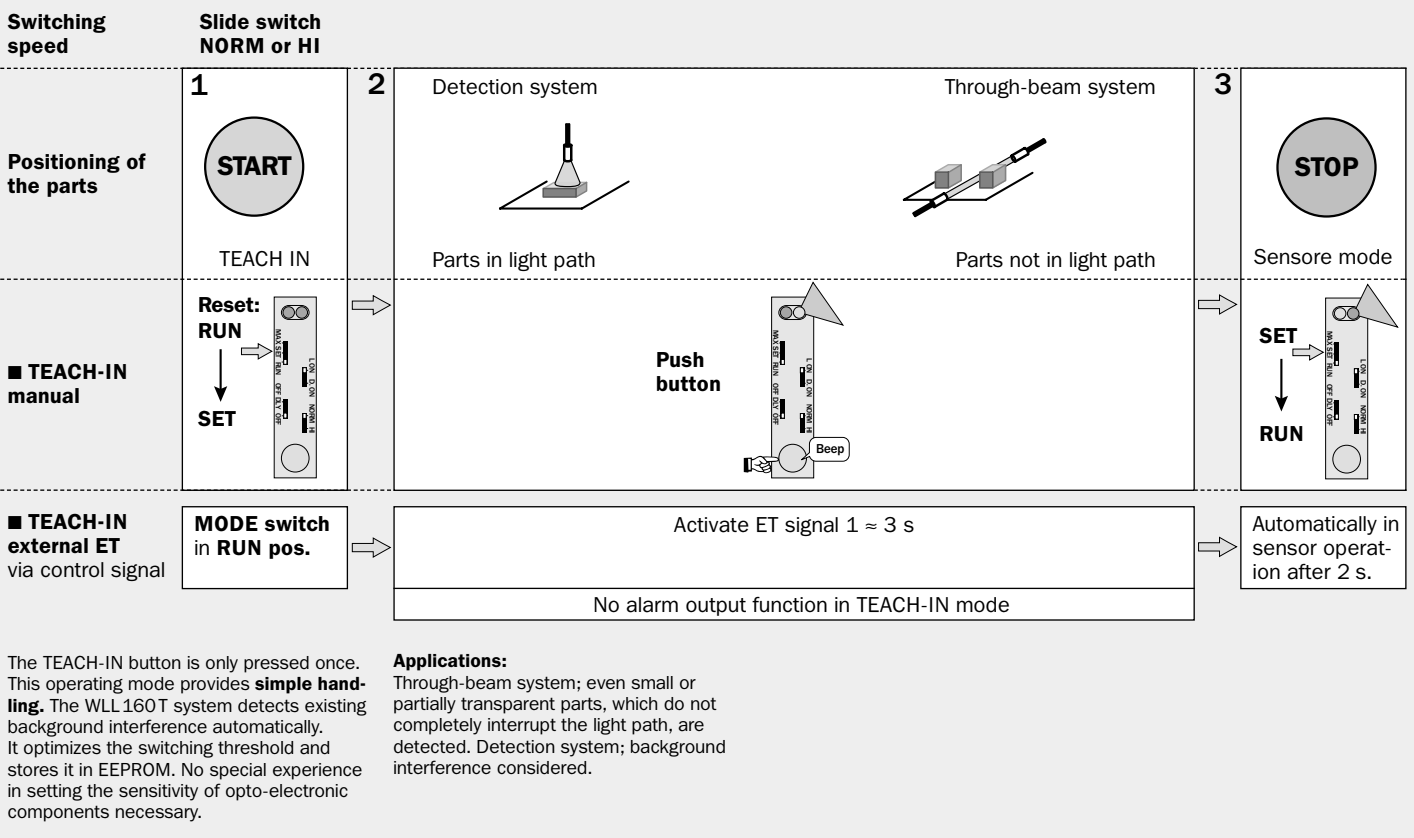

3. Max. scanning range, fixed setting; WLL 160T

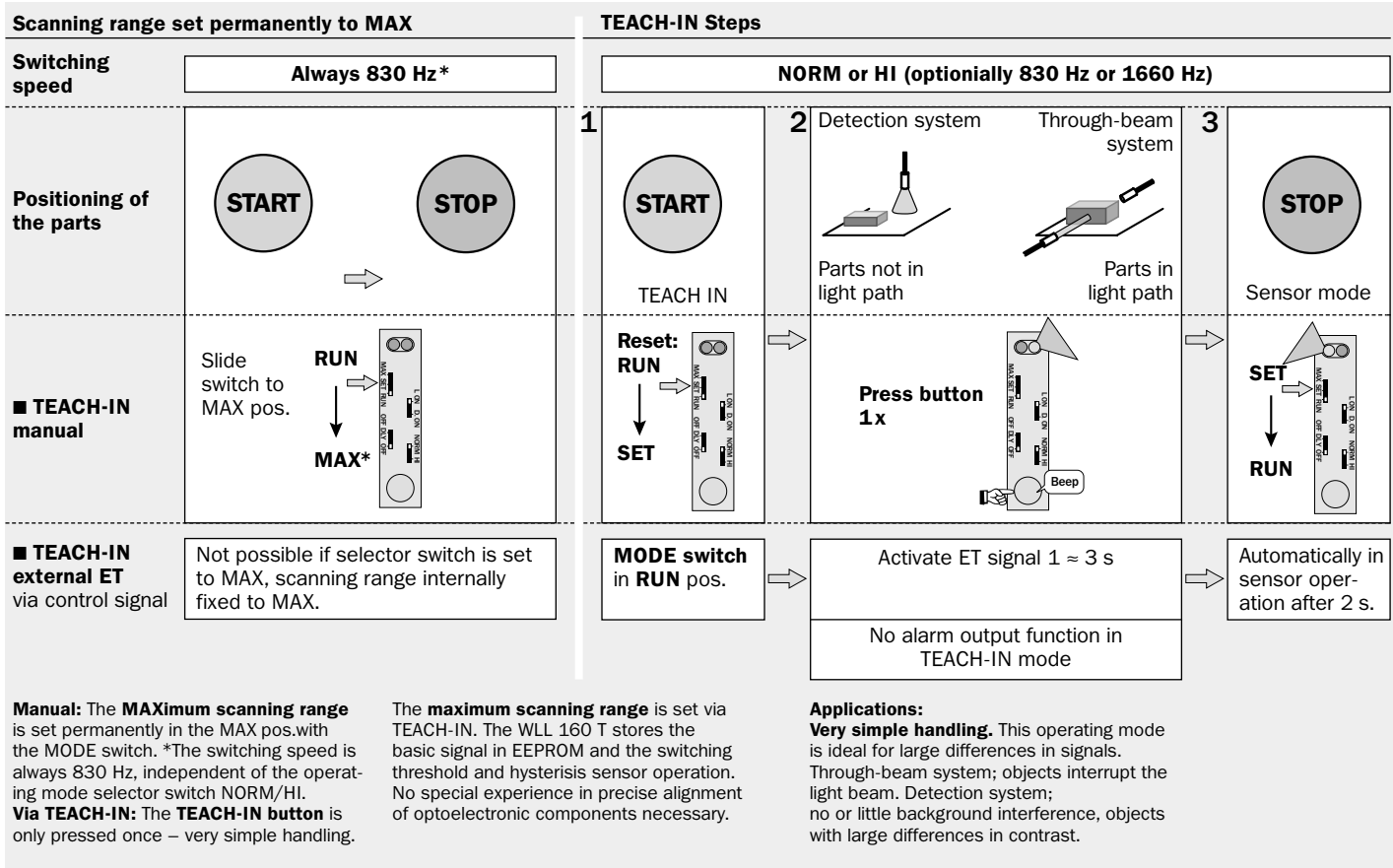

4. Moving objects; precise sensitivity adjustment (via 2x push of button); WLL 160T

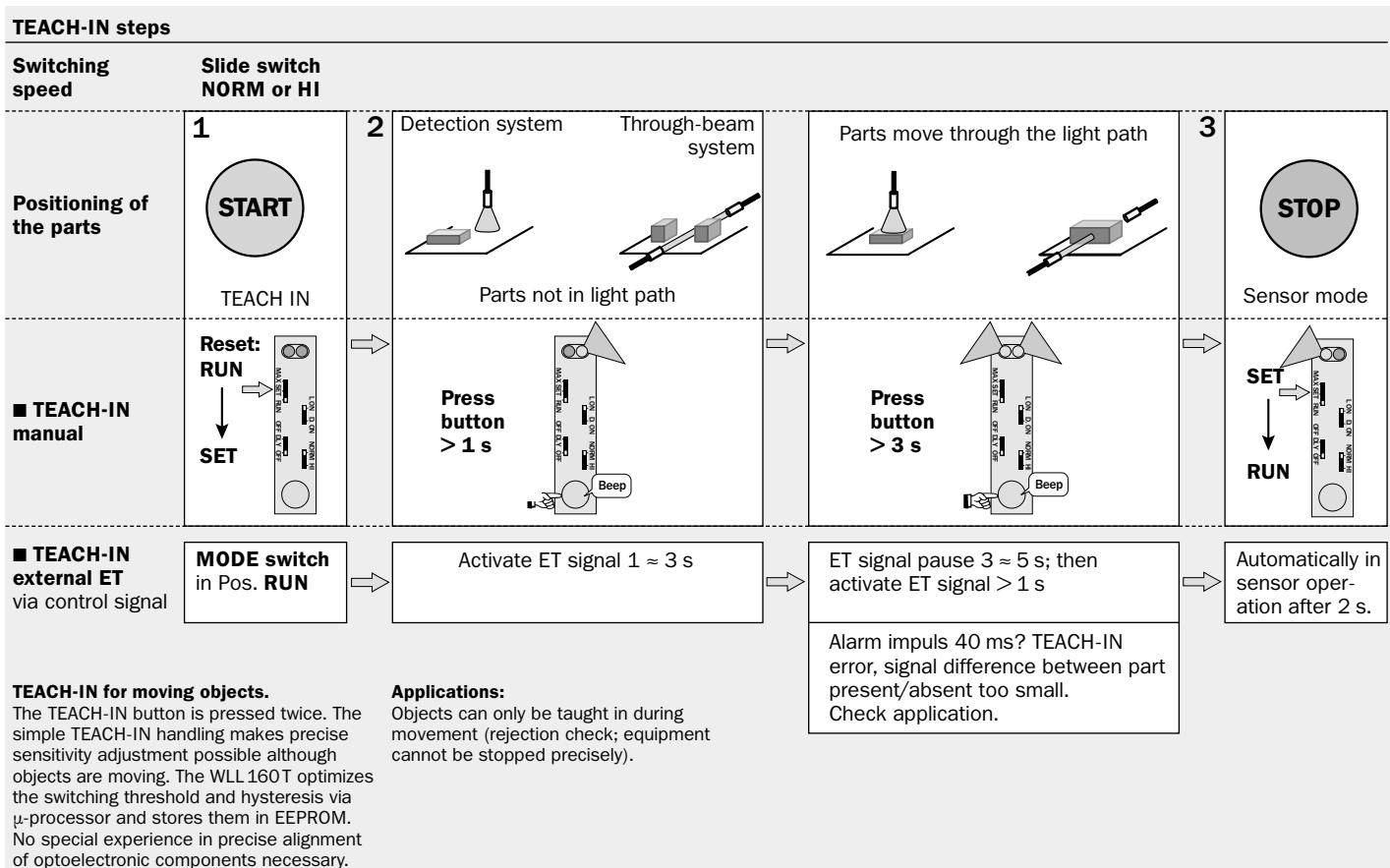

WLL 160 T TEACH-IN functions

Response time/ switching speed

NORM: 830 Hz; max. system scanning distance.

HI: 1660 Hz, system scanning distance 70 %. Select before TEACH-IN!

Off-delay T_{OFF}

For switching output Q. Optional connection, 40 ms fixed. To ensure that your control can also detect shorter events.

Selector switch switching output Q

L.ON: light-switching
D.ON: dark-switching optionally in PNP or NPN.

Connection technique

Optionally M 8 plug, 4-pin (no alarm output) or 5-wire connecting cable.

Alarm output

- **TEACH-IN mode:** signals TEACH-IN error.
- **Sensor mode (RUN):** signals insufficient signal reserve, e.g., due to contamination or misalignment (not with plug version M 8 – 4-pin).

WLL 160 T Assembly technology

Assembly and disassembly on top hat profile rail mounting by pulling the locking device.

Mounting technique

Simple snap-on on top hat profile rails. Mounting bracket supplied with equipment.

µ-processor technique with EEPROM

Permanent storage of taught-in switching threshold and hysteresis, even when there are longer interruptions of voltage.

TEACH-IN button

Sensitivity setting at the push of a button. No special knowledge of phototelectric switches required. Only active if MODE selector switch is set to SET pos. (manipulation protection).

TEACH-IN mode selector switch

Separate from operating mode functions, and consequently simple and comprehensible handling; no dual functions.

■ **MAX:** Maximum scanning range set permanently. Caution: switching speed independent of operating mode selection; switching speed always 830 Hz.

■ **SET:** WLL 160 T in manual TEACH-IN mode. Optimum switching point setting at the simple push of a button (1 or 2 times).

■ **RUN:** optionally
– **TEACH-IN manual:** The taught-in switching threshold and hysteresis are stored in EEPROM. The WLL 160 T operates in sensor mode after 2 s.

– **External TEACH-IN (ET):** Optimum system adjustment using external control signal. Ideal if the WLL 160 T is not accessible or part changes are often aligned automatically.

Fibre-optic cable lock

Press down bracket: fibre-optic cables are locked. Press the lug: fibre-optic cables are released.

Fibre-optic cable attachment

- ➔ Transmitter fibre-optic cable
- ➔ Receiver fibre-optic cable

Suitable fibre-optic cable: **plastic fibre-optic cables of the LL 3 series** (see the description of the LL 3 variants).

BUZZER

For acoustic support. Short tone after TEACH-IN = O.K.
Long tone after TEACH-IN = error or application not suitable.

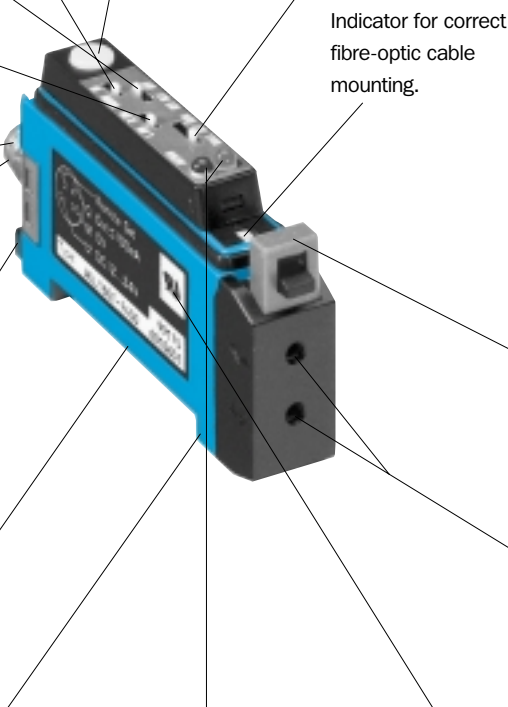

LED display red, green

- **TEACH-IN mode:**
Signalization TEACH-IN process.
Permanently blinking: TEACH-IN error.
Permanently lit: TEACH-IN o.K.
- **Sensor operation:**
LED red: switching threshold exceeded
LED green: received signal > 1.1 or < 0.9

External TEACH-IN signal ET

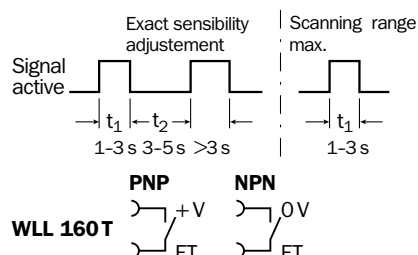

SICK