

RYSUNKI WYMIAROWE

Czujniki indukcyjne

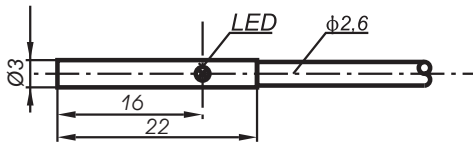

Rys. 1 - obudowa typu H3 A0

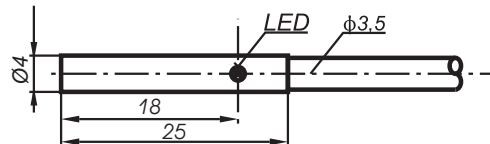

Rys. 2 - obudowa typu H4 A0

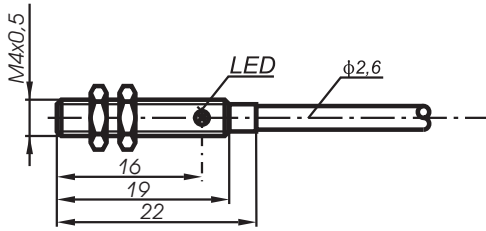

Rys. 3 - obudowa typu M4 A0

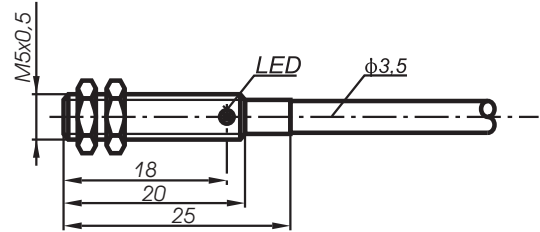

Rys. 4 - obudowa typu M5 A0

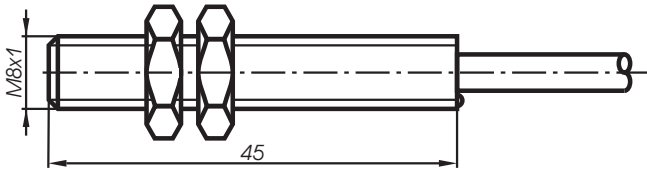

Rys. 5 - obudowa typu M8 A0

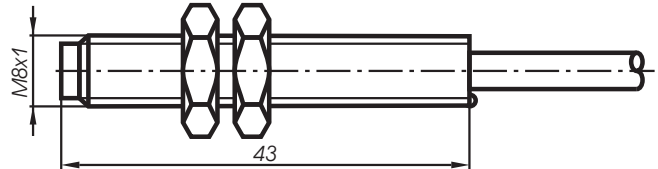

Rys. 6 - obudowa typu M8 A1

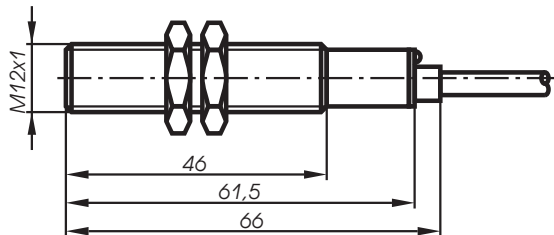

Rys. 7 - obudowa typu M12 A0

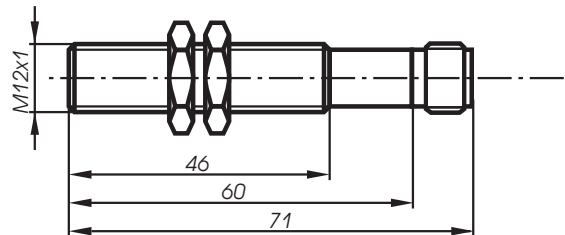

Rys. 8 - obudowa typu M12 A0 K

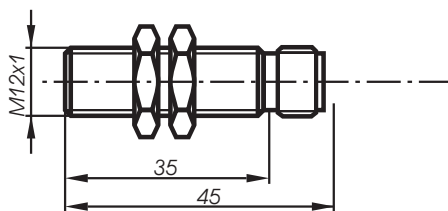
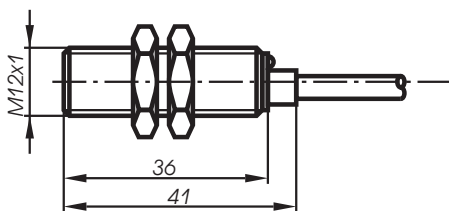

Rys. 9 - obudowa typu M12 A1

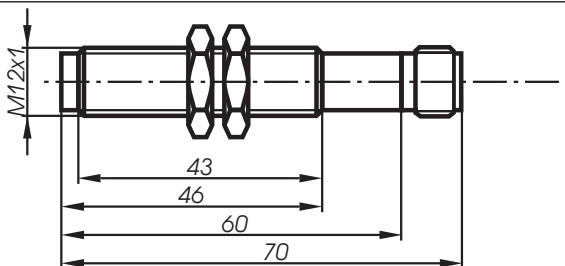
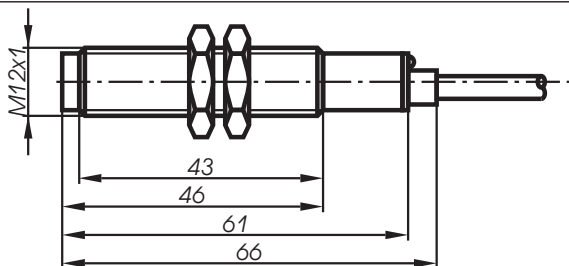

IMPOL-1
F. Szafrński Spółka jawna
 02-255 Warszawa
 ul. Krakowiaków 103
 (biurowiec SPC)

tel. (0-22) 886-56-02
 fax (0-22) 886-56-04

www.impol-1.pl
 e-mail: impol@impol-1.pl

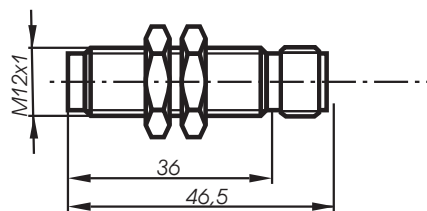
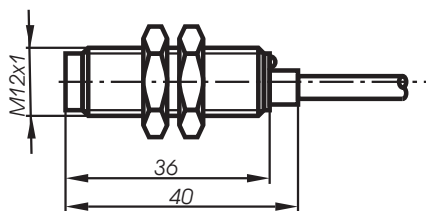

Rys. 10 - obudowa typu M12 A1 K

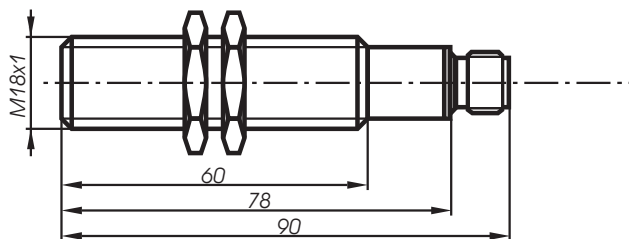
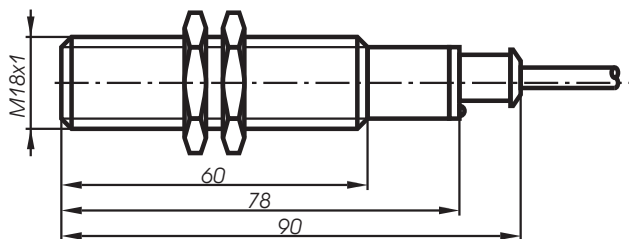

Rys. 11 - obudowa typu M18 A0

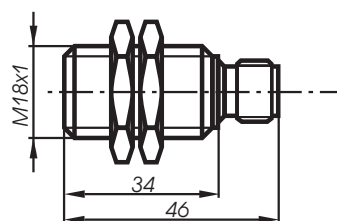
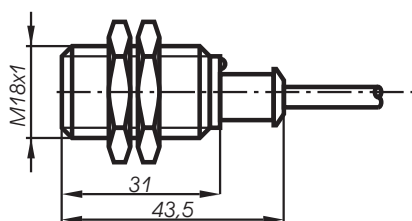

Rys. 12 - obudowa typu M18 A0K

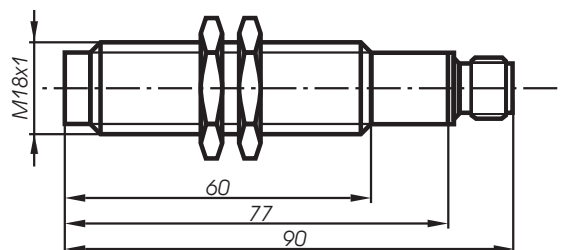
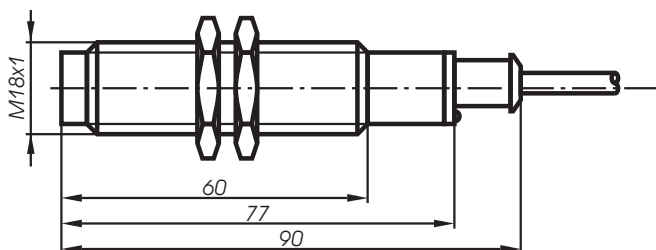

Rys. 13 - obudowa typu M18 A1

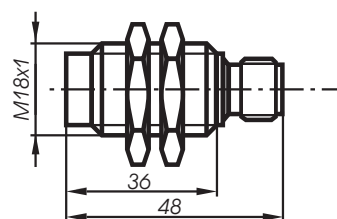
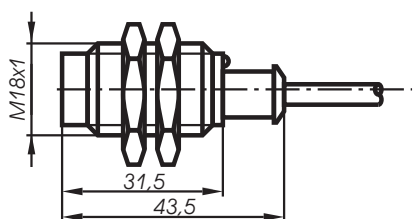

Rys. 14 - obudowa typu M18 A1K

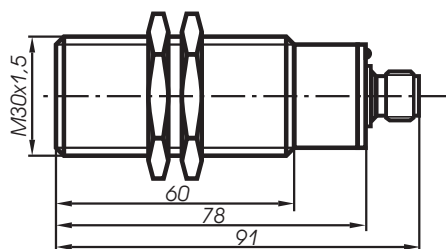
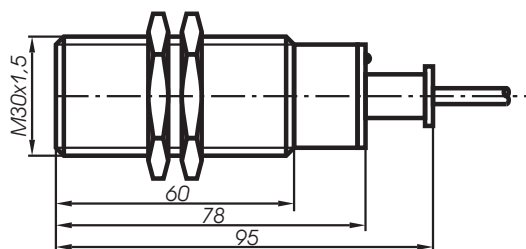

Rys. 15 - obudowa typu M30 A0



IMPOL-1
F. Szafranski Spółka jawna
 02-255 Warszawa
 ul. Krakowiaków 103
 (biurowiec SPC)

tel. (0-22) 886-56-02
 fax (0-22) 886-56-04

www.impol-1.pl
 e-mail: impol@impol-1.pl

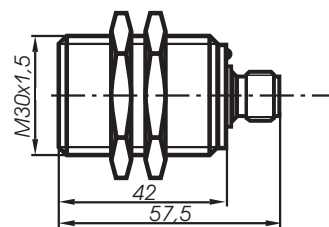
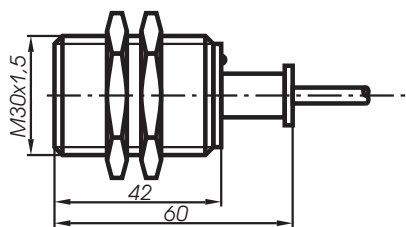

Rys. 16 - obudowa typu M30 A0K

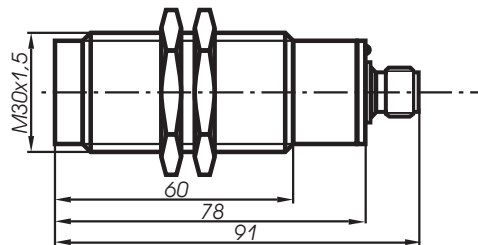
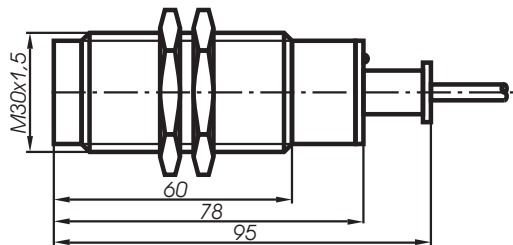

Rys. 17 - obudowa typu M30 A1

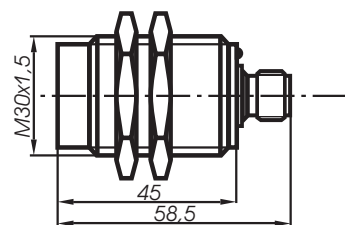
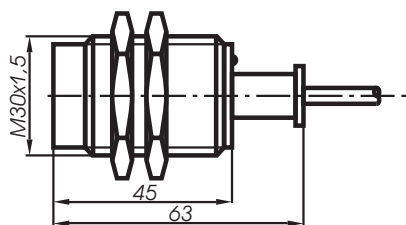

Rys. 18 - obudowa typu M30 A1K

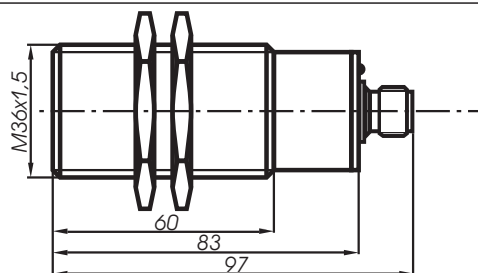
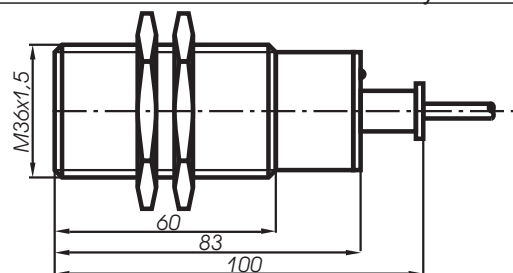

Rys. 19 - obudowa typu M36 A0

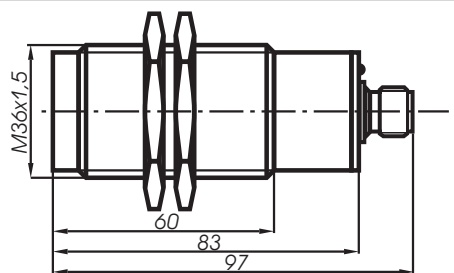
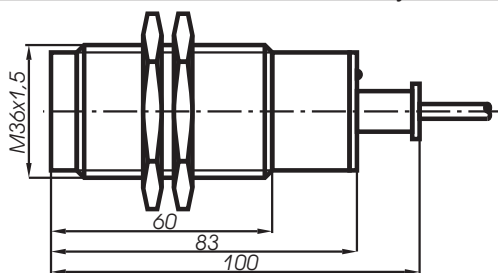

Rys. 20 - obudowa typu M36 A1

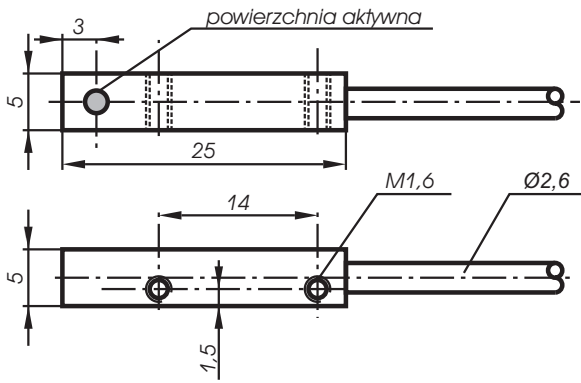

Rys. 21 - obudowa metalowa Q5

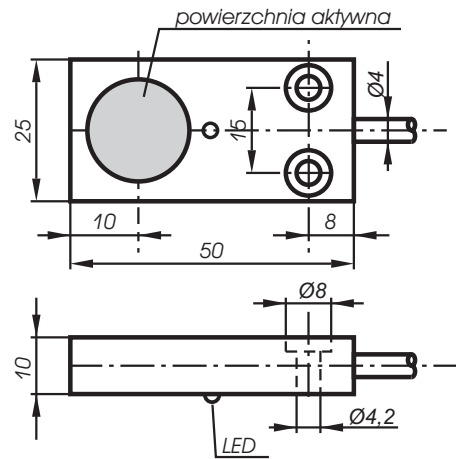

Rys. 22 - obudowa plastikowa P4

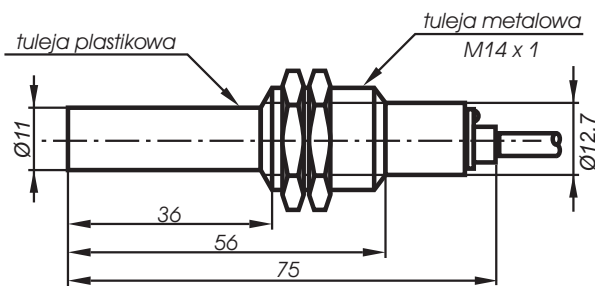

Rys. 23 - obudowa typu P5

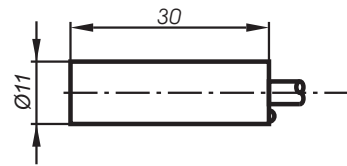

Rys. 24 - obudowa plastikowa P6

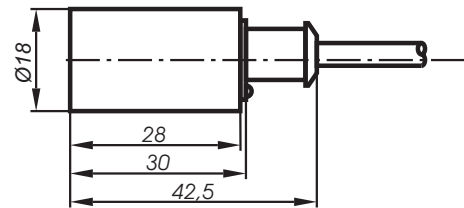

Rys. 25 - obudowa plastikowa P7

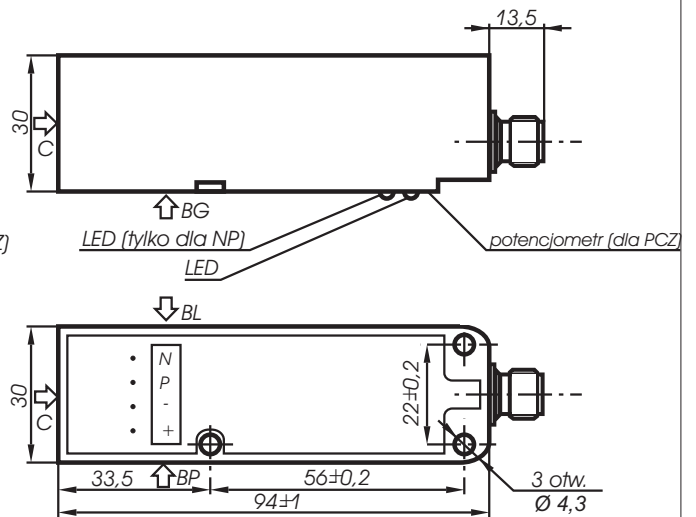
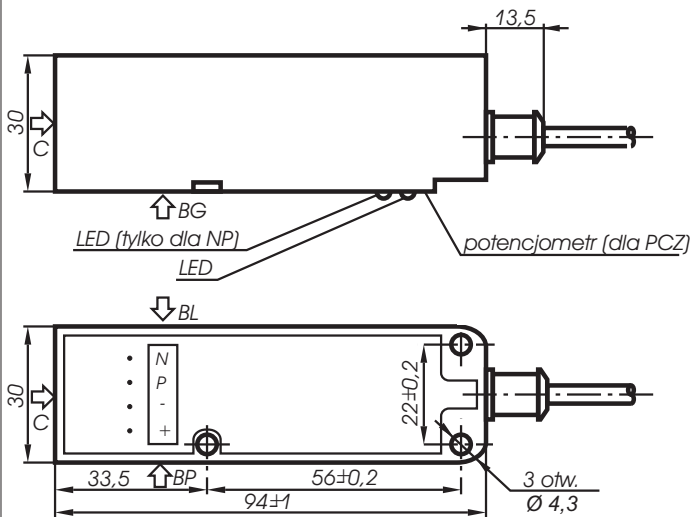

Rys. 26 - obudowa typu P1



IMPOL-1
F. Szafrński Spółka jawna
 02-255 Warszawa
 ul. Krakowiaków 103
 (biurowiec SPC)

tel. (0-22) 886-56-02
 fax (0-22) 886-56-04

www.impol-1.pl
 e-mail: impol@impol-1.pl

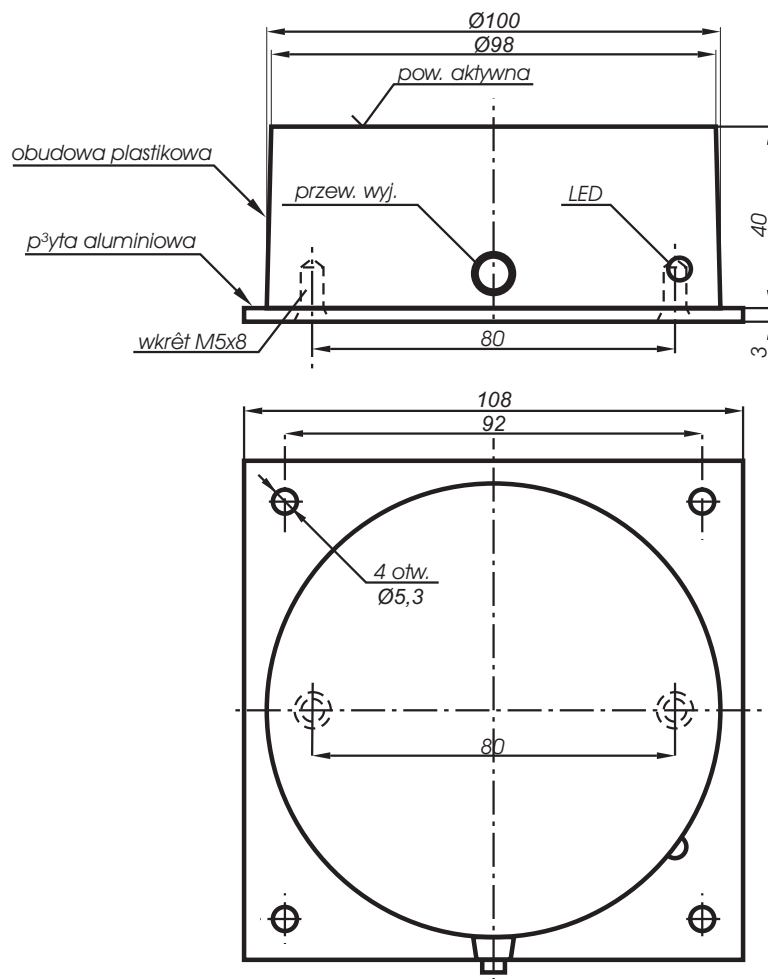

Rys. 27
obudowa typu P2

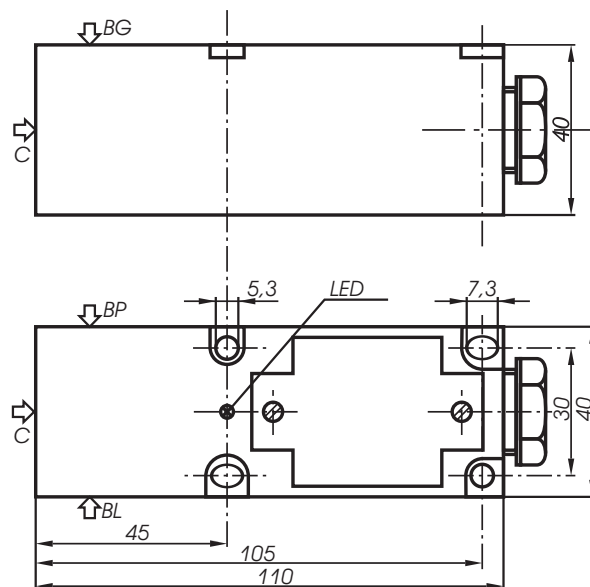

Rys. 28
obudowa plastikowa typu X

Czujniki pojemnościowe

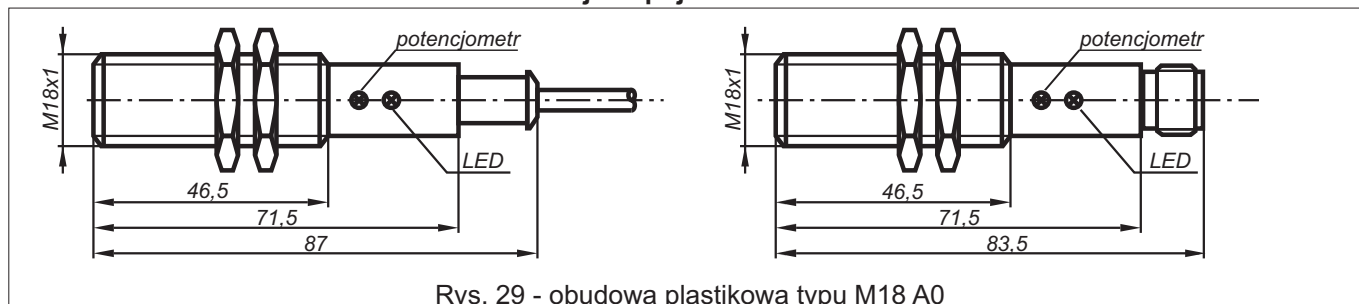

Rys. 29 - obudowa plastikowa typu M18 A0

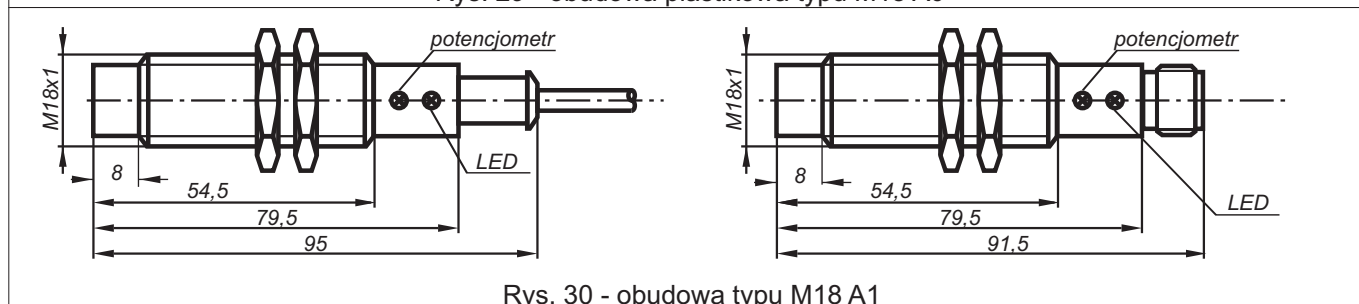

Rys. 30 - obudowa typu M18 A1

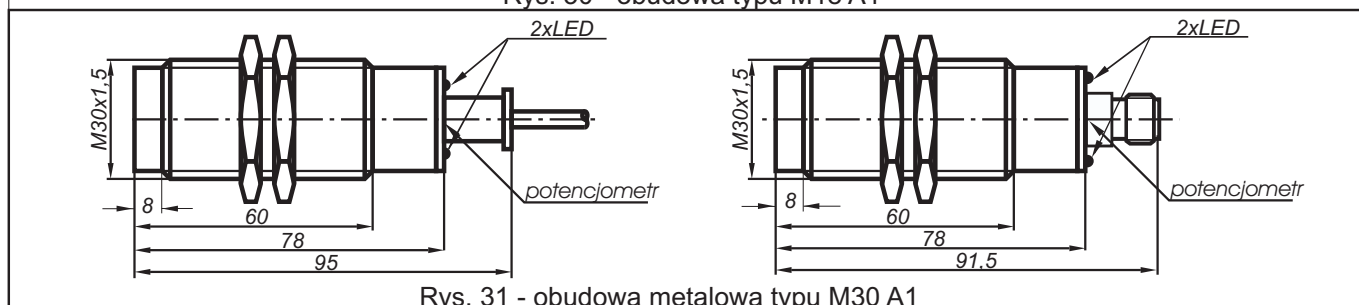

Rys. 31 - obudowa metalowa typu M30 A1

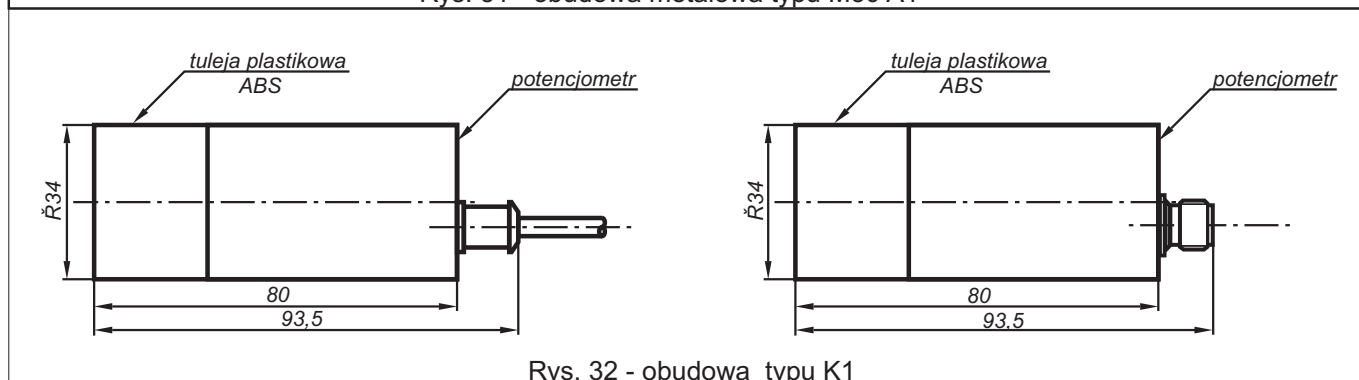

Rys. 32 - obudowa typu K1

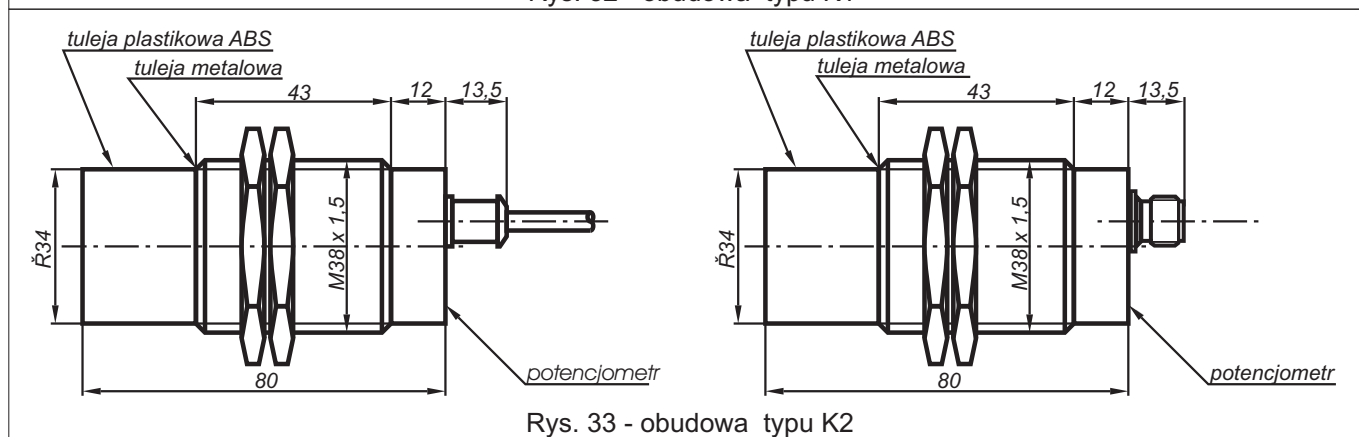

Rys. 33 - obudowa typu K2

Czujniki pojemnościowe są wykonywane także w obudowie typu P1 (patrz rys. 26 str. 15)



IMPOL-1
F. Szafrński Spółka jawna
 02-255 Warszawa
 ul. Krakowiaków 103
 (biurowiec SPC)

tel. (0-22) 886-56-02
 fax (0-22) 886-56-04

www.impol-1.pl
 e-mail: impol@impol-1.pl